

CUST #: \_\_\_\_\_

ORDER

QUOTE

DOOR WILL BE INSTALLED WITHIN 1 MILE OF SHORELINE  
 CHROMATE

PHONE #: \_\_\_\_\_

DOOR STYLE #: \_\_\_\_\_

TYPE	OPTIONS
<input type="checkbox"/> SINGLE DOOR <input type="checkbox"/> DOUBLE DOOR <input type="checkbox"/> PATIO <input type="checkbox"/> SIDELITE <input type="checkbox"/> STATIONARY <input type="checkbox"/> TRANSOM	<b>GLASS</b> <input type="checkbox"/> CLEAR GLASS - STD <input type="checkbox"/> LOW-E <input type="checkbox"/> OBSCURE GLASS

**DOGGY DOOR**

612  
 613  
 712  
 713



**HANDLESET OPTIONS**  NO LOCK

	WHITE	BLACK	BRASS	SATIN NICKEL	ANTIQUE	AGED BRONZE
#6	<input type="checkbox"/>	<input type="checkbox"/>	<input type="checkbox"/>	<input type="checkbox"/>	<input type="checkbox"/>	<input type="checkbox"/>
#7	<input type="checkbox"/>	<input type="checkbox"/>	<input type="checkbox"/>	<input type="checkbox"/>	N/A	<input type="checkbox"/>
#8	N/A	N/A	<input type="checkbox"/>	<input type="checkbox"/>	<input type="checkbox"/>	<input type="checkbox"/>
#9	N/A	N/A	<input type="checkbox"/>	<input type="checkbox"/>	<input type="checkbox"/>	<input type="checkbox"/>

**ARCH TOP STYLES 600 SERIES ONLY - TEMPLATE REQUIRED**



WITH GLASS & SCREEN [STD IF NOT SPECIFIED]  
 WITH GLASS ONLY  WITH SCREEN ONLY  
 MIN. WIDTH 30" MAX. WIDTH 42"

**SPECIAL INSTRUCTIONS**

\_\_\_\_\_

\_\_\_\_\_

\_\_\_\_\_

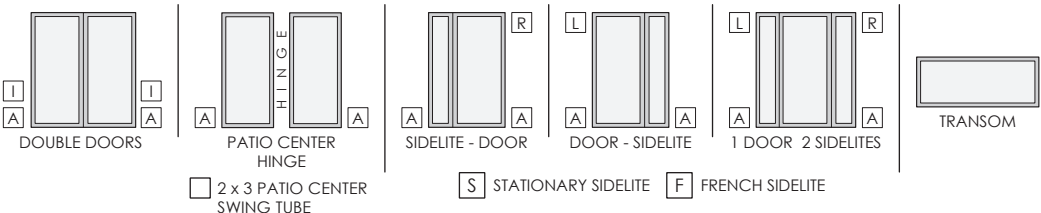

SINGLE CYLINDER #9 ONLY  
 DOUBLE CYLINDER #9 ONLY

	BRASS	ANTIQUE	SATIN NICKEL	AGED BRONZE
MAGAZINE MAIL SLOT 3 1/2 X 13	<input type="checkbox"/>	<input type="checkbox"/>	<input type="checkbox"/>	<input type="checkbox"/>
STANDARD MAIL SLOT 3 X 10	<input type="checkbox"/>	<input type="checkbox"/>	<input type="checkbox"/>	N/A
3" BOTTOM EXPANDER	<input type="checkbox"/>	<input type="checkbox"/>	<input type="checkbox"/>	<input type="checkbox"/>

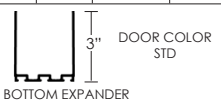

HEAT VENT

- WHITE
- ALMOND
- PEWTER GREY
- VANILLA CREAM
- BROWNSTONE
- CHOCOLATE BROWN
- COCOA
- COLONIAL BLUE
- MIDNIGHT BLUE
- FORREST GREEN
- CRIMSON
- BOYSENBERRY
- MOCHA
- FESTIVE RED
- DARK MAHOGANY PAINT
- FRUITWOOD PAINT
- BRONZE
- BLACK
- YELLOW
- PURPLE
- CORAL
- HONEY MUSTARD
- CARIBBEAN BLUE
- CHAMPAGNE METALLIC
- GRAPHITE METALLIC
- CUSTOM (RAL) \_\_\_\_\_

**OPENING SIZE**  
W \_\_\_\_\_" X H \_\_\_\_\_"

**SWING CONFIGURATION**  
**OUTSWING DOOR (STD)**  
LOOKING FROM THE OUTSIDE IN  
 Right Hinge Outswing  
 Left Hinge Outswing

**INSWING DOOR #9 Lock Only**  
LOOKING FROM THE INSIDE OUT  
 Right Hinge Inswing  
 Left Hinge Inswing

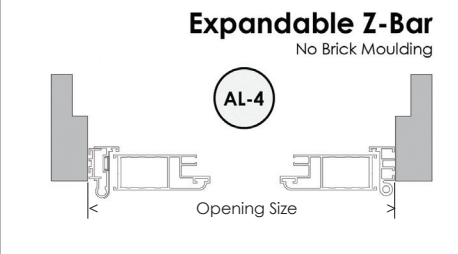
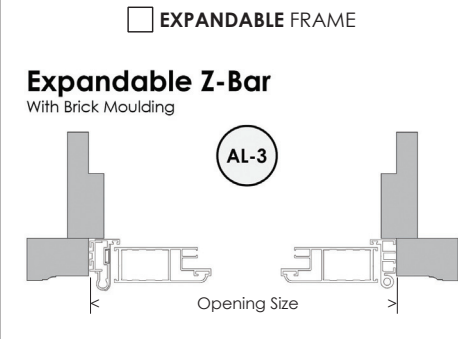
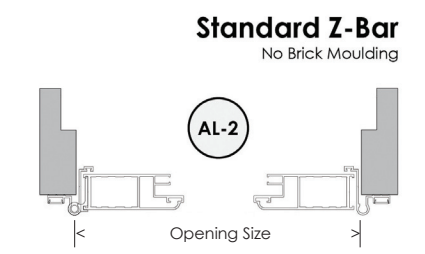
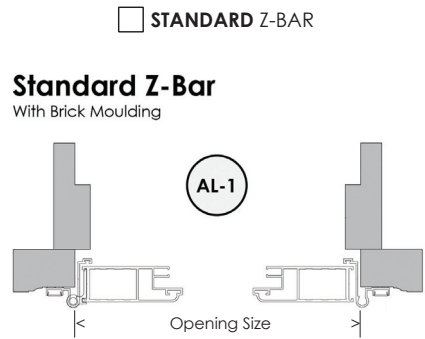

**CUSTOMER SIGNATURE** \_\_\_\_\_