

LASTING ELEGANCE

ENTRY AND ALUMINUM STORM DOORS 2011



HMI is the one-stop-shop for your entryway needs, whether it's our Entry Doors; Aluminum Storm Doors; or Security Storm Doors. Our advanced production facilities make HMI one of the few companies that manufacture doors according to customer specifications. We are a *make-to-order* company treating each door as a custom door whether it is a standard size or not.

DOOR STYLES

Lasting Elegance Entry Doors

HMI's entry doors are designed to the highest standards of energy efficiency, security, and sturdiness without sacrificing beauty. They are available in: *steel* - smooth or textured finishes; and *fiberglass* - textured. Made to enhance your entryway and satisfy the unique taste of each homeowner, we offer a variety of rich colors with a comprehensive collection of decorative glass.

We set the industry standard for custom, top of the line entry doors. With over 80 available door styles (also available in 5 archtop styles), our entry doors can accommodate all homeowner needs and wants. We offer the most secure steel door on the market because our 19" lock block has a 14 gauge steel reinforcement channel along with a 20-gauge steel door skin. This combination offers 40% more protection than home center doors.

Elite Storm Doors

HMI's storm doors embrace balance and proportion while using durable design concepts and long lasting materials. *Elite* is all about providing comfort, light, distinction, and value. We offer 10 distinctive styles to assure your preference is always met. Whether it is a classic full view or convenient self-storing storm door you get what you want. With traditional clear glass, grooved glass and glass with coming you can choose the look that fits your style.

Security Storm Doors

HMI's security storm doors create harmony between security and style. Heavy 16 gauge welded steel frame tempered glass and 70 styles to choose from will satisfy your need for safety while meeting your style standards.

The heavy-duty hinges have steel vault pins to keep the door secure even when tested by the elements. They are tamper resistant to provide added safety against break-ins. The adjustable pneumatic closer allows you to set how fast or slow your door will close. The extruded metal Z-bar with weather-stripping ensures a tight seal against the elements.

Custom made to fit your entryway our security storm doors are available in 5 arch top styles. The HMI Security Storm Door gives you the peace of mind you need and the beauty you desire.



DECORATIVE AND CLEAR GLASS STYLES

- 4** FIBERGLASS DOORS
- 8** HEIRLOOM - N, NS
- 10** BELLFLOWER - BF
- 11** PARIS - X
- 12** NOUVEAU - A, AS, AP
- 14** ORNAMENTAL - MD
- 15** IMPRESSIONS - LI
- 16** ELAN - Q
- 17** STRATFORD - STA-AB, STA-P
- 18** EMBASSY - Y, YS
- 20** TAJ - K, KS
- 21** WINSLOW - C, CS
- 22** PANAMA - P, PS
- 23** RIVIERA - L
- 24** FANLITE/CAMBERTOP - Z, ZS, L, N, NS, D, G, GS, B, BS, H, HS, I, IS, M, MS, X, JS
- 26** PHOTO GALLERY
- 28** ONE LITE (GLASS WITHOUT GRIDS)
- 30** EXTERNAL GRIDS
- 31** INTERNAL GRIDS
- 32** MINI BLINDS
- 33** PATIO DOORS WITH SLIDING SCREEN

SAFEGUARD™ OPTIONS

- 34** THE SAFEGUARD™ ADVANTAGE
- 35** JAMB & FRAMING OPTIONS
- 36** 12 POINT LOCK
- 37** 4 POINT LOCK
- 38** HARDWARE
- 40** FRENCH SIDELITES & QUICKSHIP

STORM DOORS

- 41** ELITE STORM DOORS
- 42** SELF-STORING/FULL SCREEN
- 43** GROOVED GLASS
- 44** OVERLAY CAMING
- 45** HMI ENGINEERING/CAM LOCK EXTRUDED HINGE & HEAT VENT
- 46** HARDWARE
- 47** PAINT/POWDER COAT/STAIN

BACK COVER SECURITY DOOR

FIBERGLASS

PREMIUM RUSTIC FIBERGLASS COLLECTION



HME 296 HS 242RO



HME 295 HSE 268AP

STANDARD

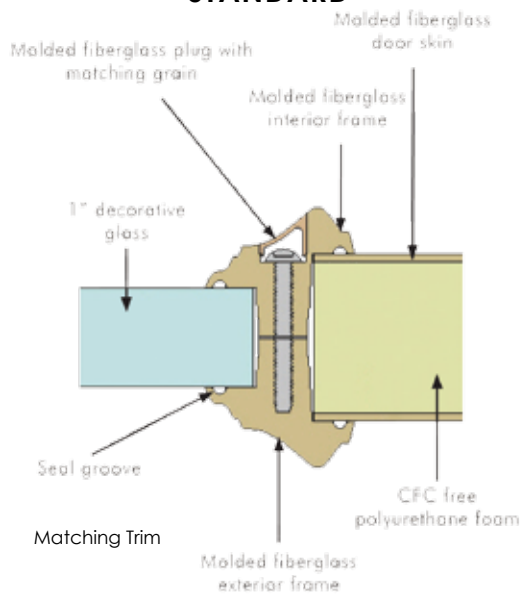

HME 274 HME 297 HME 295 HME 296 HME 279 HME 298

Aluminum Reinforcement Door Edge For Replacement Fiberglass Doors

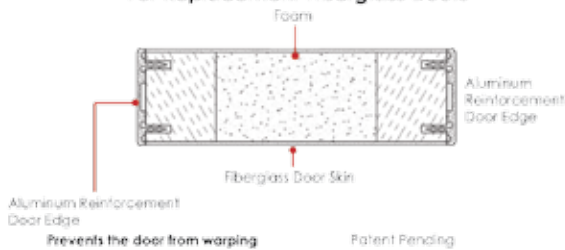

Available in Cherry Grain Only



CHERRY GRAIN

ENTRY DOOR

PREMIUM TRADITIONAL FIBERGLASS COLLECTION



HME 220 HM 242 HME 224 HME 307 HME 260 HME 266 HME 268

Available in Cherry, Oak and Mahogany Grains



CHERRY GRAIN



OAK GRAIN



MAHOGANY GRAIN

FIBERGLASS ENTRY DOORS

PRIVACY RATING

0



HME 286

PRIVACY RATING

0



HME 288

PRIVACY RATING

0



HME 290

HME 290 Door ▼

PRIVACY RATING

8



● HME 292HN



● HSE 292HN

PRIVACY RATING

0



HME 284

● Black Palma Carving Only - Stock



STD TRIM



▲ HME 246



▲ HME 252



HME 282

THE FIBERGLASS ADVANTAGE

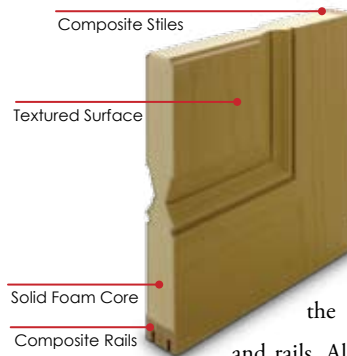

In addition to Steel Entry Doors, HMI also offers a wide range of Fiberglass Entry Doors. Available in textured finish, Fiberglass doors feature the beauty and detail of conventional wood doors but with added insulation value provided by the solid foam core and composite stiles and rails. All Fiberglass Doors are available in any HMI paint or stain finish.

Refer to pages 26-29 for more styles to choose from.

ENTRY DOOR

FIBERGLASS ENTRY DOORS

<p>PRIVACY RATING 8</p> <p>Brass Caming Only - Special Order</p>	<p>STD TRIM</p> <p>● HME 97CH</p>	<p>PRIVACY RATING 0</p>	<p>STD TRIM</p> <p>● HME 281</p>	<p>PRIVACY RATING 8</p> <p>Satin Nickel Caming Only - Stock</p>	<p>STD TRIM</p> <p>● HSE 281</p>	<p>PRIVACY RATING 8</p>	<p>STD TRIM</p> <p>● HME 281BC5</p>	<p>STD TRIM</p> <p>● HSE 281BC5</p>	<p>PRIVACY RATING 8</p> <p>Black Patina Caming Only - Stock</p>	<p>STD TRIM</p> <p>● HME 281BC4</p>	<p>STD TRIM</p> <p>● HSE 281BC4</p>
--	-----------------------------------	-------------------------	----------------------------------	---	----------------------------------	-------------------------	-------------------------------------	-------------------------------------	---	-------------------------------------	-------------------------------------

HME 281 Door ▼

<p>PRIVACY RATING 5</p> <p>Black Patina - Special Order</p>	<p>STD TRIM</p> <p>● HME 273</p>	<p>PRIVACY RATING 5</p> <p>Stock</p>	<p>STD TRIM</p> <p>● HME 294PR</p>	<p>PRIVACY RATING 5</p> <p>Special Order</p>	<p>STD TRIM</p> <p>● HS 242PR</p>	<p>PRIVACY RATING 5</p>	<p>STD TRIM</p> <p>● HME 258ML</p>	<p>PRIVACY RATING 5</p>	<p>STD TRIM</p> <p>● HSE 258ML</p>
---	----------------------------------	--------------------------------------	------------------------------------	--	-----------------------------------	-------------------------	------------------------------------	-------------------------	------------------------------------

● HME 294PRB ● HS 242PRB ▲ HME 258MLS ● HSE 258MLS



Aluminum Reinforcement Door Edge For Replacement Fiberglass Doors

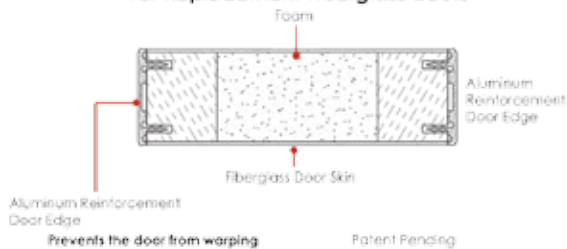

▲ HME 256

STD TRIM - Standard Trim With Screw Plugs ▲ Fir Textured Steel ▲ Oak Textured Steel

Fur Grain
 Mahogany Grain
 Oak Grain

HEIRLOOM GLASS

BY ODL

HEIRLOOM

PRIVACY RATING 7



● Stock
● Special Order

STD TRIM

● HME 244N
● HME 244NS

PRIVACY RATING 7



● Stock
● Special Order

STD TRIM

● HS 242N
● HS 242NS

PRIVACY RATING 7



● Stock
● Special Order

STD TRIM

● HME 268N
● HME 268NS



● HSE 268N
● HSE 268NS

PRIVACY RATING 7



● Stock
● Special Order

STD TRIM

● HME 272N
● HME 272NS

PRIVACY RATING 7



● Stock
● Special Order

STD TRIM

● HME 266N
● HME 266NS

- Standard Trim with Factory Installed Screw Plugs inside of the House



● HME 262N Door and HT 200 Transom ▼



PRIVACY RATING 7



● Stock
● Special Order

STD TRIM

● HME 258N
● HME 258NS

PRIVACY RATING 7



● Stock
● Special Order

STD TRIM

● HME 226N
● HME 226NS

PRIVACY RATING 7



● Stock
● Special Order

STD TRIM

● HME 254N
● HME 254NS



● HSE 224N
● HSE 224NS



STD TRIM

PRIVACY RATING 7

● Stock
● Stock

- HME 218N
- HME 218NS



PRIVACY RATING 7

● Special Order
● Stock

- HME 239N
- HME 239NS



STD TRIM

PRIVACY RATING 7

● Stock
● Special Order

- HME 238N
- HME 238NS



STD TRIM

● HME 255N Door, ● HS 242N Sidelites and ● HT 200N Transom ▲

- Fashion with function
- No screw hole plugs

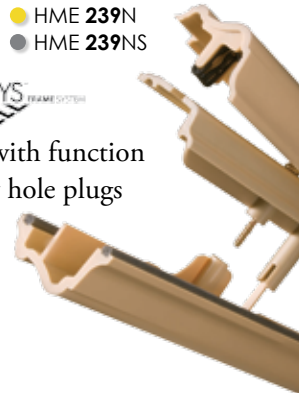

CLEAR BEVEL CLEAR GLUE CHIP



PRIVACY RATING 7

● Stock
● Stock

- HME 230N
- HME 230NS



PRIVACY RATING 7

● Special Order
● Stock

- HME 284N
- HME 284NS



- HSE 268N
- HSE 268NS

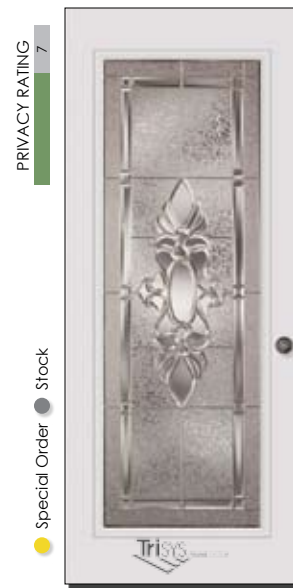

PRIVACY RATING 7

● Special Order
● Stock

- HM 242N
- HM 242NS



GLASS DETAIL

Trisys - Trisys Trim System - No Screw Plugs

STD TRIM - Standard Trim with Screw Plugs

BELFLOWER GLASS

BY ODL



- Fashion with function
- No screw hole plugs



● HME 249BF Door ● HS 242BF Sidelites and ● HT 200BF Transom ▼



● HT 200BF



GLASS DETAIL



- Standard Trim with Factory Installed Screw Plugs inside of the House



PARIS GLASS BY ODL



● HME 307X Door and ● HS 242X Sidelites ▼

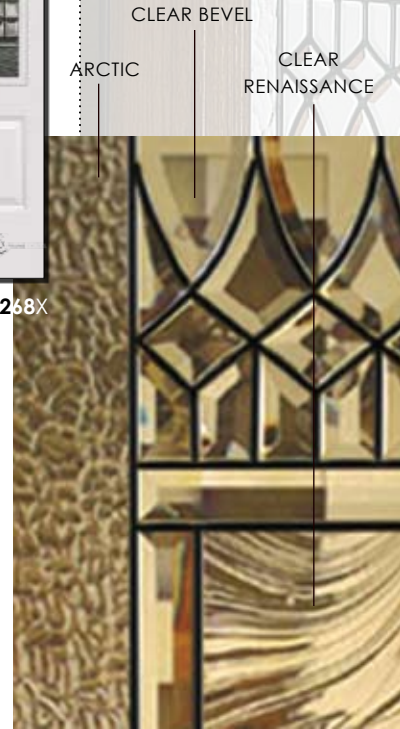

GLASS DETAIL



Trisys - Trisys Trim System - No Screw Plugs

STD TRIM - Standard Trim with Screw Plugs

NOUVEAU GLASS

BY ODL



- Fashion with function
- No screw hole plugs

PRIVACY RATING 7

● Special Order ● Stock



- HM 242A
- HM 242AS



- HS 242A
- HS 242AS

PRIVACY RATING 7

● Special Order ● Stock



- HME 258A
- HME 258AS
- HME 258AP

PRIVACY RATING 7

● Special Order ● Stock



- HME 266A
- HME 266AS
- HME 266AP

● HM 244AS Door and ● HS 242AS Sidelites ▼

PRIVACY RATING 7

● Special Order ● Stock



- HME 226A
- HME 226AS
- HME 226AP

CLEAR BEVEL
CLEAR GLUE CHIP



GLASS DETAIL



GLASS

- Standard Trim with Factory Installed Screw Plugs inside of the House



PRIVACY RATING 7



PRIVACY RATING 7



PRIVACY RATING 7



● Special Order ● Stock

● Special Order ● Stock

● Special Order ● Stock

- HME 268A
- HME 268AS
- HME 268AP

- HSE 268A
- HSE 268AS
- HSE 268AP

- HME 272A
- HME 272AS
- HME 272AP

- HME 254A
- HME 254AS
- HME 254AP

- HSE 224A
- HSE 224AS
- HSE 224AP



- HT 230A
- HT 230AS
- HT 230AP



- HT 200A
- HT 200AS
- HT 200AP

PRIVACY RATING 7



PRIVACY RATING 7



PRIVACY RATING 7



PRIVACY RATING 7



● Special Order ● Stock

● Special Order ● Stock

● Special Order ● Stock

● Special Order ● Stock

- HME 230A
- HME 230AS
- HME 230AP

- HME 218A
- HME 218AS
- HME 218AP

- HME 307A
- HME 307AS
- HME 307AP

- HME 238A
- HME 238AS
- HME 238AP

ORNAMENTAL GLASS

BY ODL



- Fashion with function
- No screw hole plugs



ARTIC

GLASS DETAIL

PRIVACY RATING 8

● Wrought Iron Only - Special Order

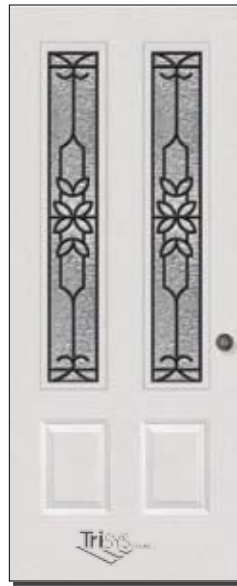

● HME 272MD

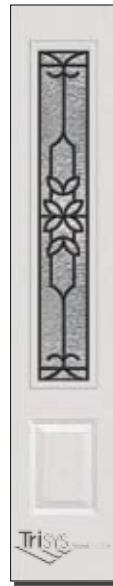

HSE 268MD

PRIVACY RATING 8

● Wrought Iron Only - Special Order

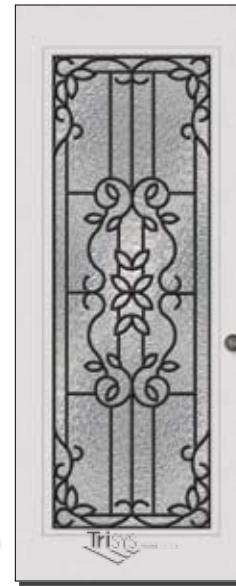

● HM 242MD

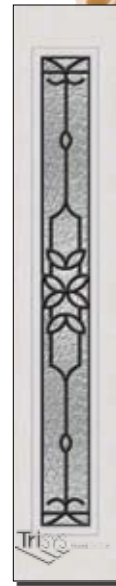

HS 242MD

● HME 268MD Door and ● HS 268MD Sidelites ▼



IMPRESSIONS GLASS BY ODL

SEVERE WEATHER GLASS



● HME 224LI Door ● HSE 224LI Sidelites and ● HT 200LI Transom ▼



GLASS DETAIL



ELAN GLASS

BY WESTERN REFLECTIONS



- Fashion with function
- No screw hole plugs

PRIVACY RATING 8

• Black Chrome Coming Only - Special Order



• HM 242Q

PRIVACY RATING 8

• Black Chrome Coming Only - Special Order



• HME 268Q

PRIVACY RATING 8

• Black Chrome Coming Only - Special Order

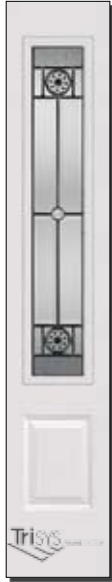

• HSE 268Q

PRIVACY RATING 8

• Black Chrome Coming Only - Special Order



• HME 307Q

PRIVACY RATING 8

• Black Chrome Coming Only - Special Order



• HME 272Q

- Standard Trim with Factory Installed Screw Plugs inside of the House



• HM 242Q Door and • HS 242Q Sidelites ▼

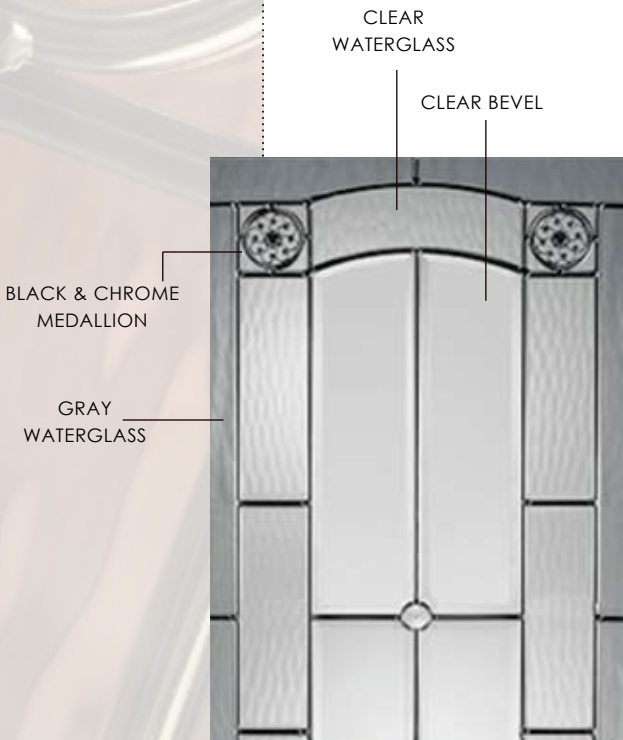

GLASS DETAIL



STRATFORD

STRATFORD GLASS BY WESTERN REFLECTIONS



PRIVACY RATING 7

● Stock ● Stock ● Stock

- HM 242STA-AB
- HME 242STA-PL



PRIVACY RATING 7

● Stock ● Stock ● Stock

- HS 242STA-AB
- HS 242STA-PL



PRIVACY RATING 7

● Stock ● Stock ● Stock

- HME 266STA-AB
- HME 266STA-PL



PRIVACY RATING 7

● Stock ● Stock ● Stock

- HME 255STA-AB
- HME 255STA-PL



GLASS DETAIL

● HM 242STA-AB Door and ● HS 242STA-AB Sidelites ▼

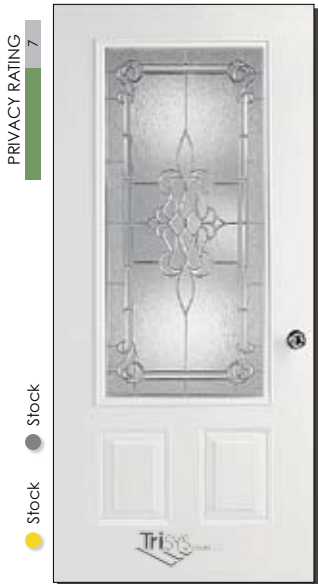

PRIVACY RATING 7

● Stock ● Stock ● Stock

- HME 268STA-AB
- HME 268STA-PL

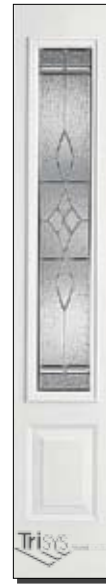

- HSE 268STA-AB
- HSE 268STA-PL



- HT 200STA-AB
- HT 200STA-PL



- HT 230STA-AB
- HT 230STA-PL



Trisys - Trisys Trim System - No Screw Plugs

STD TRIM - Standard Trim with Screw Plugs

EMBASSY GLASS

BY RSL

EMBASSY

PRIVACY RATING 5

● Special Order

● Stock



STD TRIM

- HME 244Y
- HS 242Y
- HME 244YS
- HS 242YS



STD TRIM

- HME 244Y
- HS 242Y
- HME 244YS
- HS 242YS

PRIVACY RATING 7

● Special Order

● Stock



STD TRIM

- HME 224Y
- HSE 224Y
- HME 224YS
- HSE 224YS



STD TRIM

- HME 230Y
- HSE 224Y
- HME 230YS
- HSE 224YS

PRIVACY RATING 7

● Special Order

● Stock

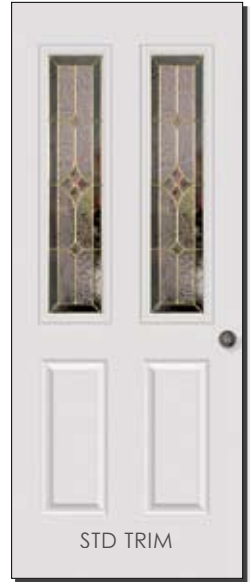

STD TRIM

- HME 230Y
- HSE 224Y
- HME 230YS
- HSE 224YS

- Standard Trim with Factory Installed Screw Plugs inside of the House



● HME 238Y Door and ● HS 242Y Sidelite ▼

PRIVACY RATING 7

● Special Order

● Stock



STD TRIM

- HME 266Y
- HSE 268Y
- HME 266YS
- HSE 268YS



STD TRIM

- HME 266Y
- HSE 268Y
- HME 266YS
- HSE 268YS



STD TRIM

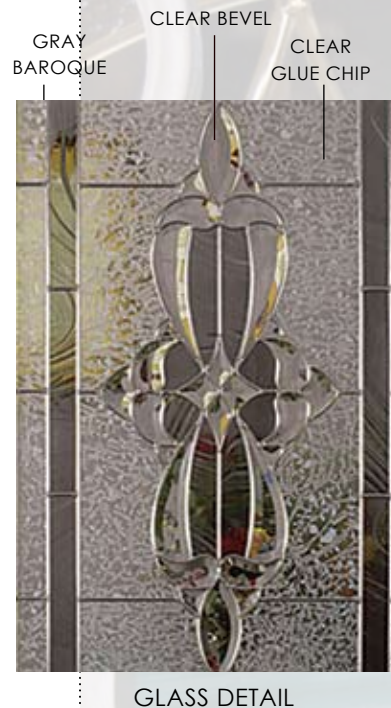

● HME 224Y Door and ● HS 242Y Sidelite ▲



● HT 200Y ● HT 200YS



● HT 230Y ● HT 230YS



● HME 268Y ● HSE 268Y
● HME 268YS ● HSE 268YS

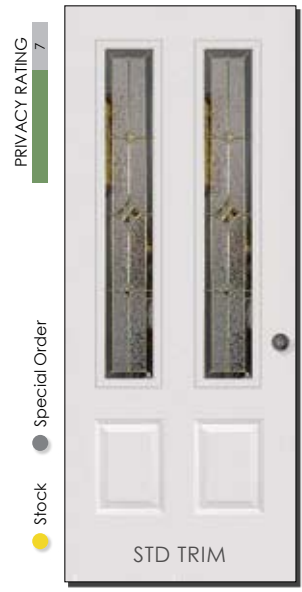

● HME 272Y ● HME 272YS

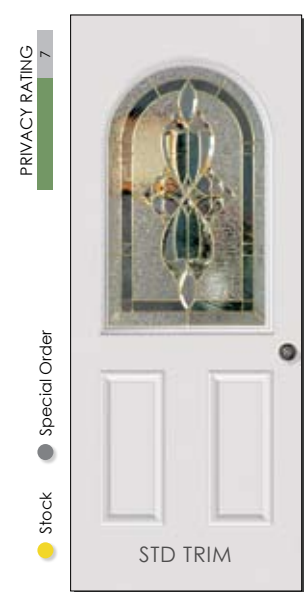

● HME 226Y ● HME 226YS

STD TRIM - Standard Trim with Screw Plugs

TAJ GLASS

BY RSL

TAJ / TWINS

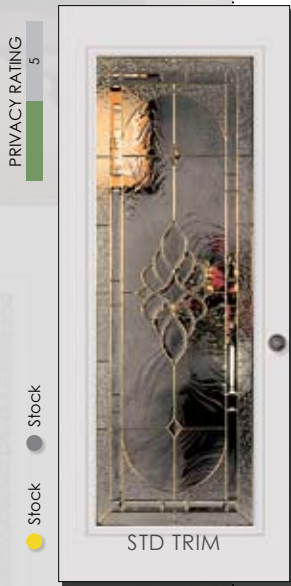

- HM 242K
- HM 242KS



- HS 242K
- HS 242KS



- HME 268K
- HME 268KS



- HSE 268K
- HSE 268KS



- HME 226K
- HME 226KS



- HSE 224K
- HSE 224KS

● HME 238K Door ▼

CLEAR BEVEL

CLEAR BAROQUE



GLASS DETAIL



- HME 258K
- HME 258KS



- HME 248K
- HME 248KS



STD TRIM



- HT 200K
- HT 200KS



- HT 230K
- HT 230KS

- Standard Trim with Factory Installed Screw Plugs inside of the House



WINSLOW GLASS BY MEDIEVAL

CLEAR
GLUE CHIP

CRANBERRY



GLASS DETAIL



- HME 224C
- HSE 224C
- HME 224CS
- HSE 224CS



- HME 268C
- HS 242C
- HME 268CS
- HS 242CS

● HME 258C Door and ● HS 242C Sidelites ▼



- HME 230C
- HME 230CS

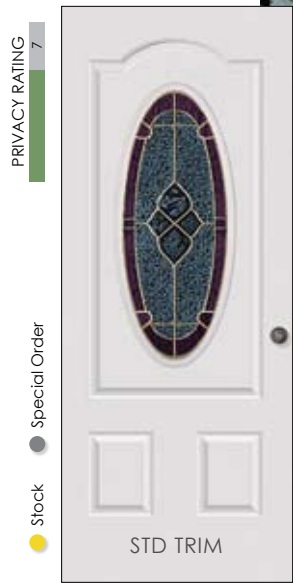

- HME 266C
- HME 266CS



STD TRIM

PANAMA GLASS

BY SPECIALTY

CLEAR BEVEL
AQUA
GRANITE

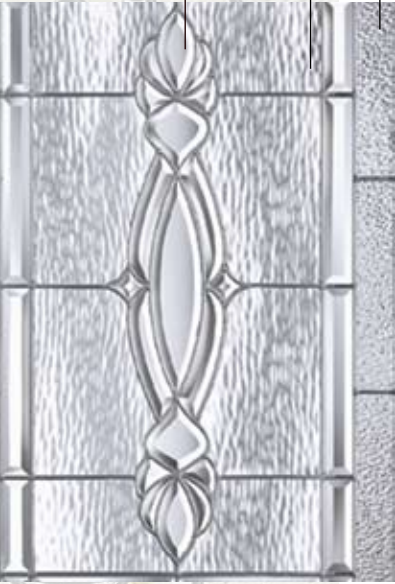

GLASS DETAIL



● HME 226PS Door, ● HS 242PS Sidelites and ● HT200PS Transom▲



● HT 200P ● HT 200PS



● HT 230P ● HT 230PS

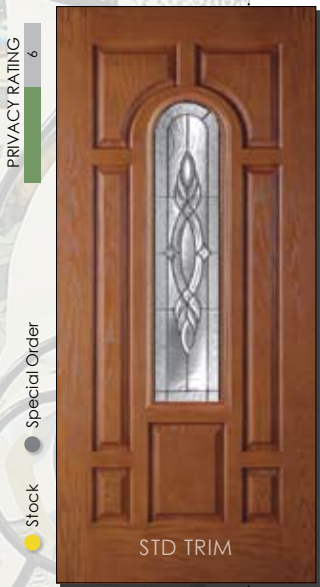

PRIVACY RATING
6

● Stock
● Special Order

● HME 284P
● HME 284PS



PRIVACY RATING
6

● Stock
● Special Order

● HME 224P
● HME 224PS



● HSE 224P
● HSE 224PS



PRIVACY RATING
8

● Stock
● Special Order

● HME 268P
● HME 268PS



● HSE 268P
● HSE 268PS

- Standard Trim with Factory Installed Screw Plugs inside of the House



RIVIERA GLASS BY SPECIALTY



● HME 226L Door and ● HSE 232L Sidelites ▲



GLASS DETAIL

FANLITE/CAMBER TOP GLASS

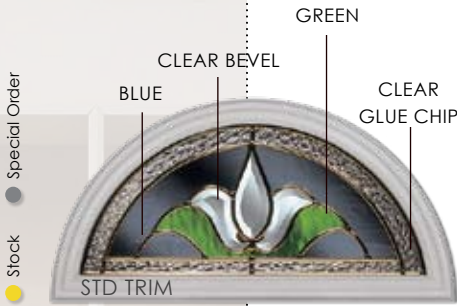

● HME 218H ● HME 218HS

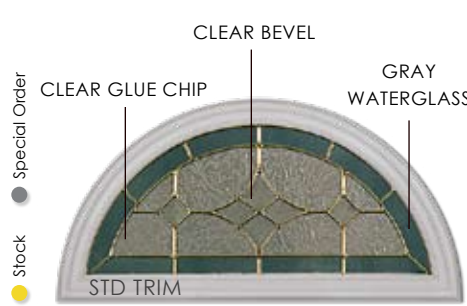

● HME 218Z ● HME 218ZS



● HME 218L

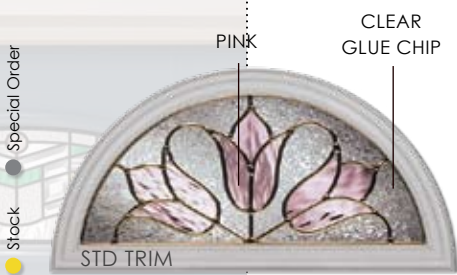

● HME 218I ● HME 218IS

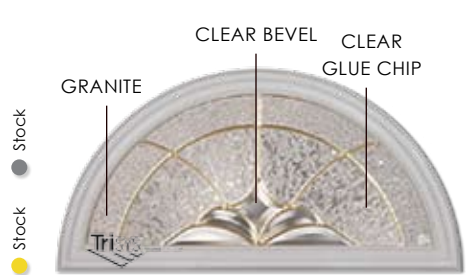

● HME 218N ● HME 218NS

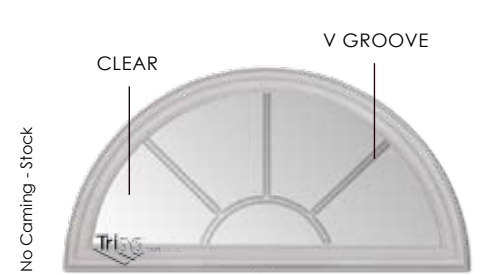

HME 218D

● HME 218N Door and ● HSE 224N Sidelites ▼

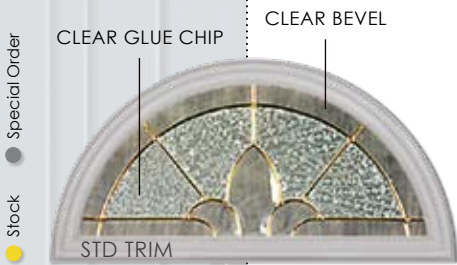

● HME 218G ● HME 218GS



● HME 218B ● HME 218BS

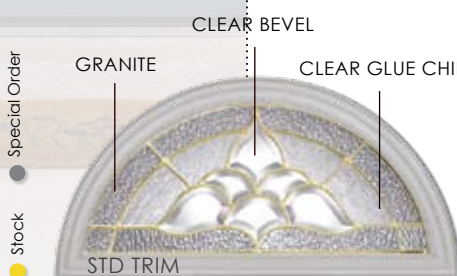

● HME 218M ● HME 218MS



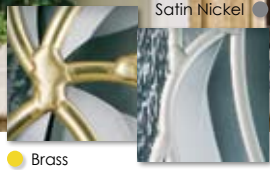

STD TRIM

Satin Nickel ●

● Brass

● HME 307NS Door ▲

Beautifully trimmed with Brass or Satin Nickel coming these Fanlight/Camber Top styles add beauty and elegance to your entryway. Each glass style has a stock and special order coming style denoted by a colored dot - yellow ● for Brass and gray ● for Satin Nickel.

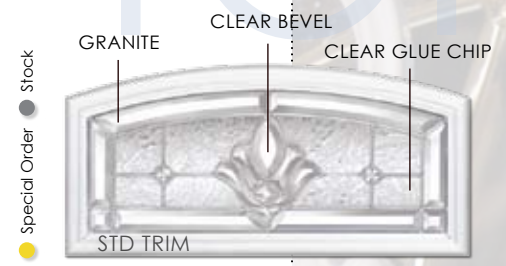
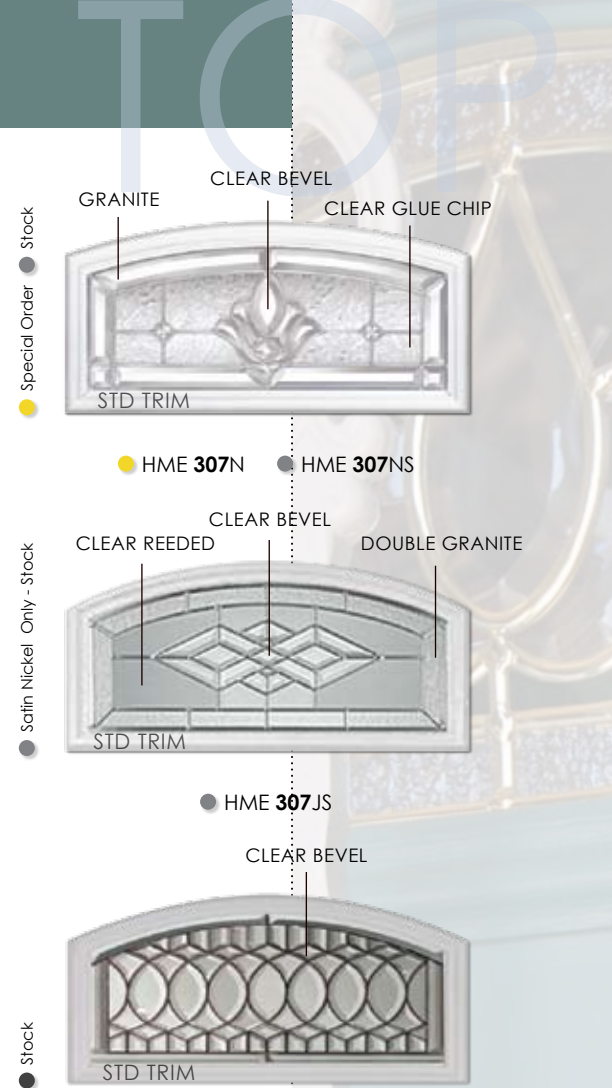

● HME 307N ● HME 307NS

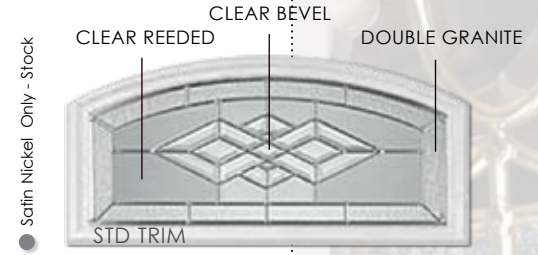

● HME 307JS

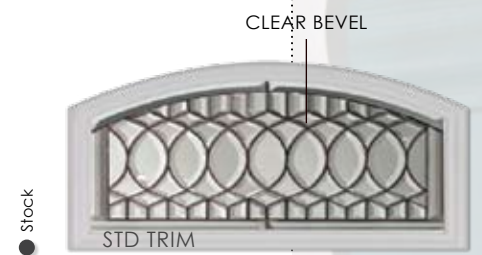

● HME 307X



STD TRIM

HME 249-3L Door, HS 242B Sidelites and HT200B Transom ▼



HME 247



MANTEL SHELF OPTIONAL



HME 249



HME 249-6L



HME 249TR



HME 253 Door and ● HS 242MD Sidelites ▼



HME 246 Door and ● HS 242NS Sidelites ▼

HM 90 Door with Raised Panels and HS 242AS Sidelites ▼



HM 217 Door with Raised Trim, In and Out , HS 242B Sidelites and HT 200B Transom ▼



HM200 SERIES • ONE LITE STYLES

All HM200 Series Doors & Sidelites are available in Textured or Smooth Steel



◀ HM 242 Door with Rain Glass

CUSTOM ARCH TOP STYLES

Customers can choose from a variety of shapes to fit their home's decor, ranging from a Full Arch to a Cathedral Top. Each arch top door is made to the customer's specific doorway. Please refer to the icons on top of each door style for available and matching arch tops.

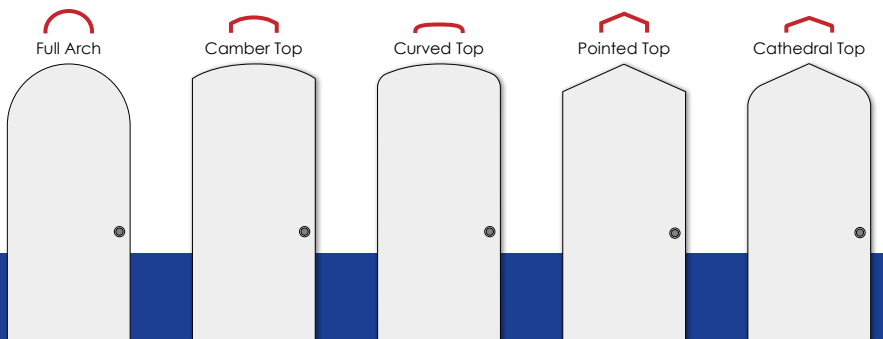

HM200 SERIES • ONE LITE STYLES

All HM200 Series Doors & Sidelites are available in Textured or Smooth Steel

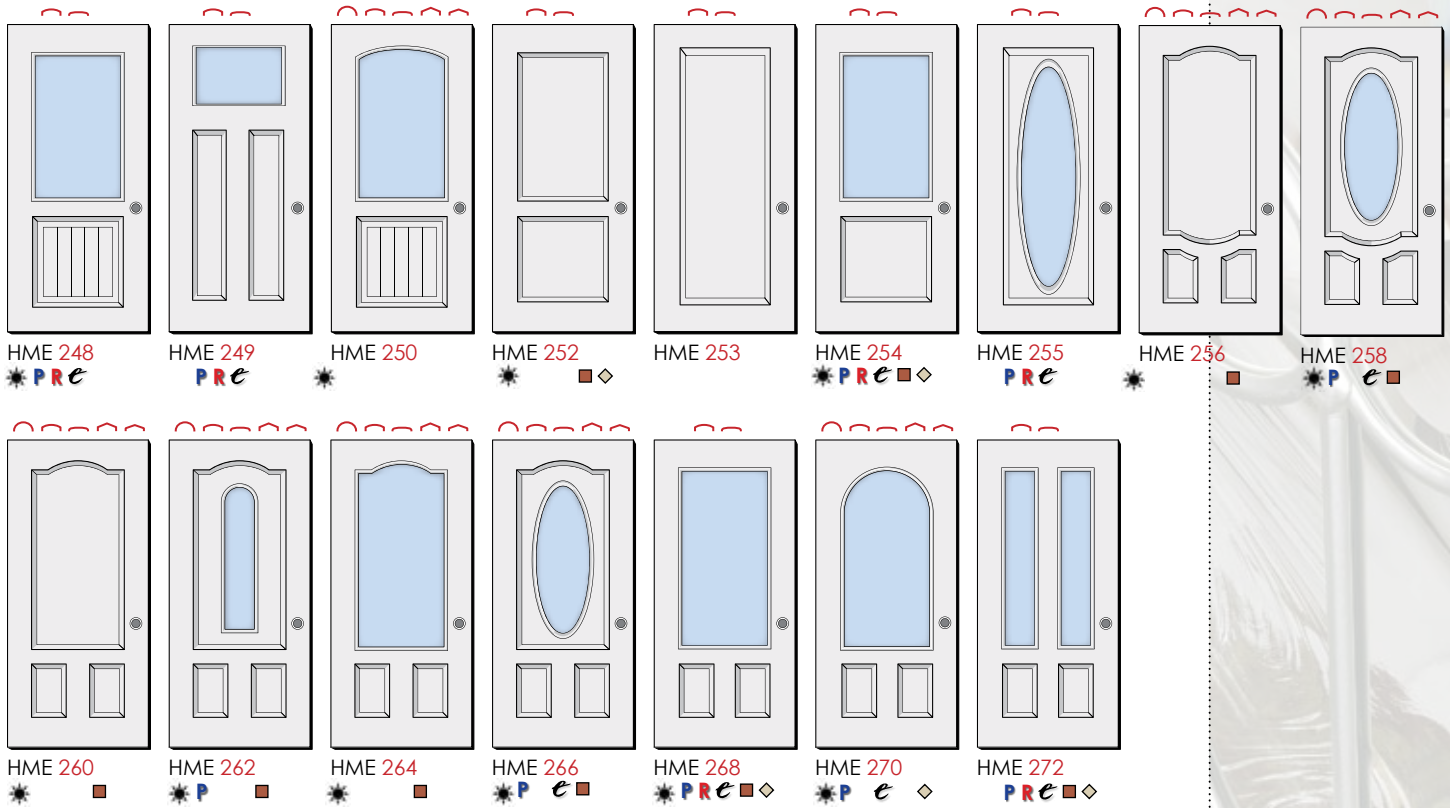

HS200 SERIES • ONE LITE SIDELITES

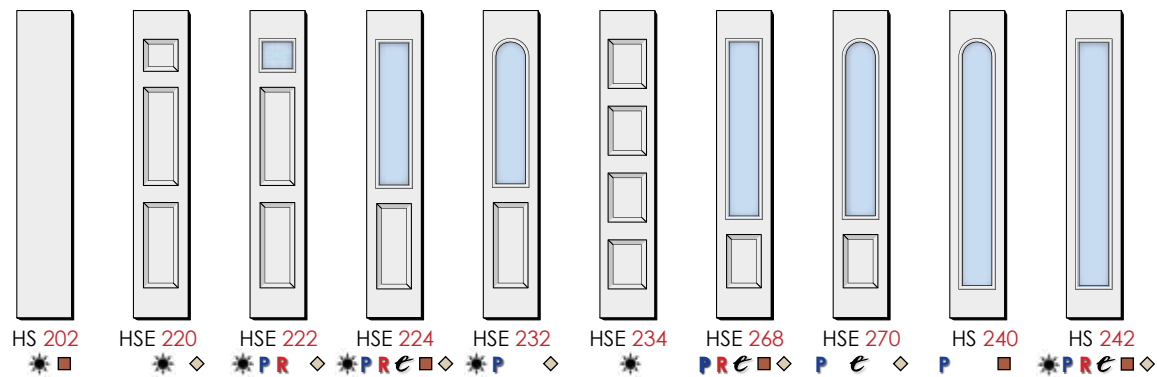

DOGGY DOOR

We have not forgotten your best friends. A pet door can be added to doors without bottom embossed panels.

HT200 SERIES • ONE LITE TRANSOMS

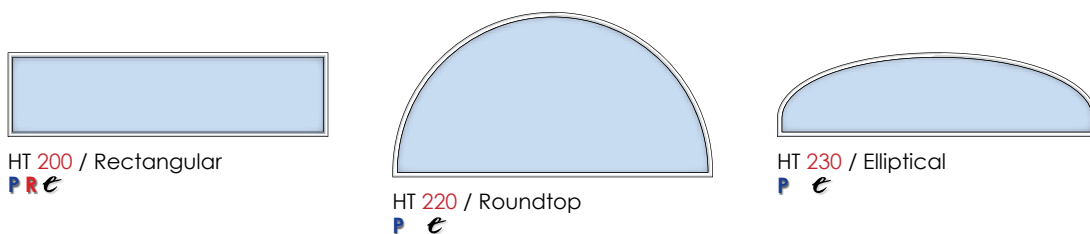

CUSTOM DOOR OPTIONS:

- R Rain Glass P Pebbled Glass ■ Also Available in Textured Fiberglass
- e Available in Low-E Glass ◇ Also Available with Raised Trim Panels
- * 2011 Stimulus Bill Tax Credit Qualified with Low-E, Low-E Plus and Decorative Glass with coming.

Available Arch tops are Highlighted in Red



HM300 SERIES • EXTERNAL GRID STYLES

All HM300 Series Doors & Sidelites are available in Textured or Smooth Steel

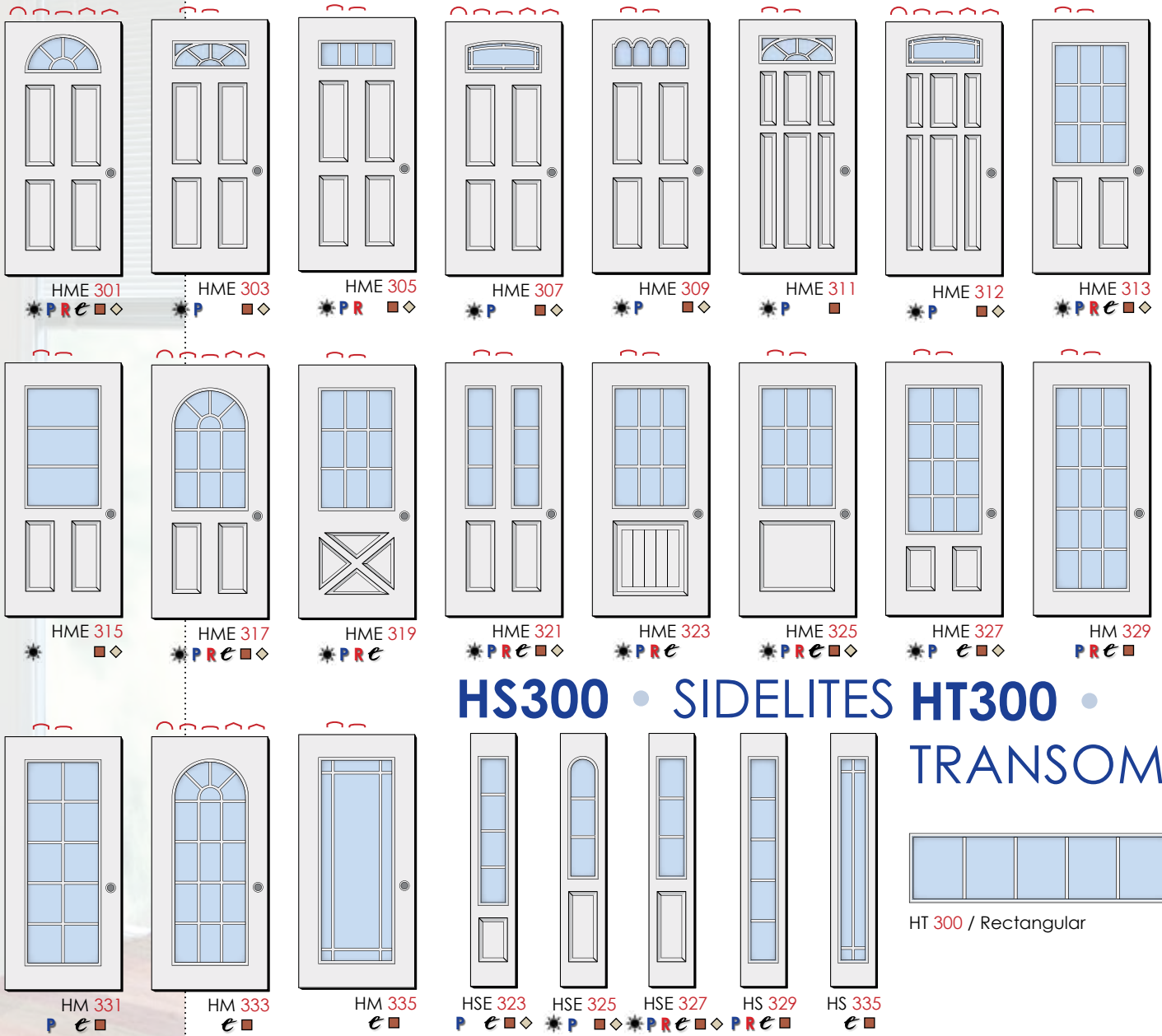

HS300 • SIDELITES HT300 • TRANSOM

SIMULATED DIVIDED LIGHT



CUSTOM DOOR OPTIONS:

- Rain Glass ■ Pebbled Glass ■ Also Available in Textured Fiberglass
- e Available in Low-E Glass ◇ Also Available with Raised Trim Panels ⤴ ⤵ ⤶ ⤷ Available Arch tops are Highlighted in Red
- ★ 2011 Stimulus Bill Tax Credit Qualified with Low-E, Low-E Plus and Decorative Glass with caming.

HM400 SERIES • INTERNAL GRID STYLES

All HM400 Series Doors & Sidelites are available in Textured or Smooth Steel



Vent Lites

HS400 • SIDELITES

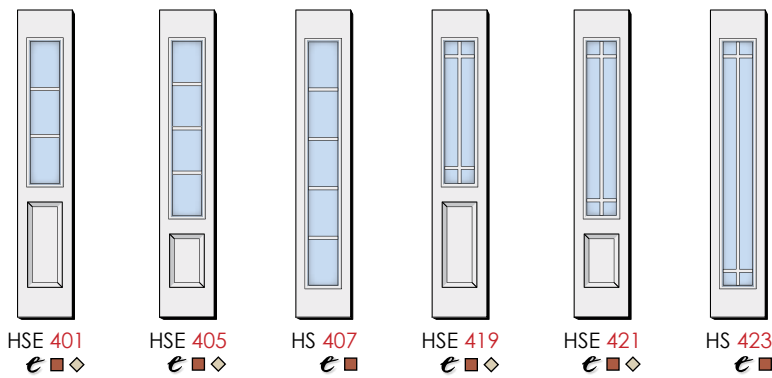

INTERNAL GRIDS

Thermally sealed between two pieces of tempered glass, Internal Grids provide the same classic beauty as external grids, but with the added advantage of an easy-to-clean design. The internal grids are available in two different colors: White and Champagne.



White



Champagne

HT400 • TRANSOMS

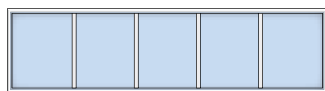

HT 400 / Rectangular

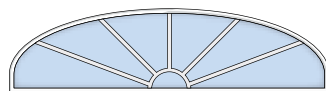

HT 430 / Elliptical



MINI BLIND ENTRY DOORS

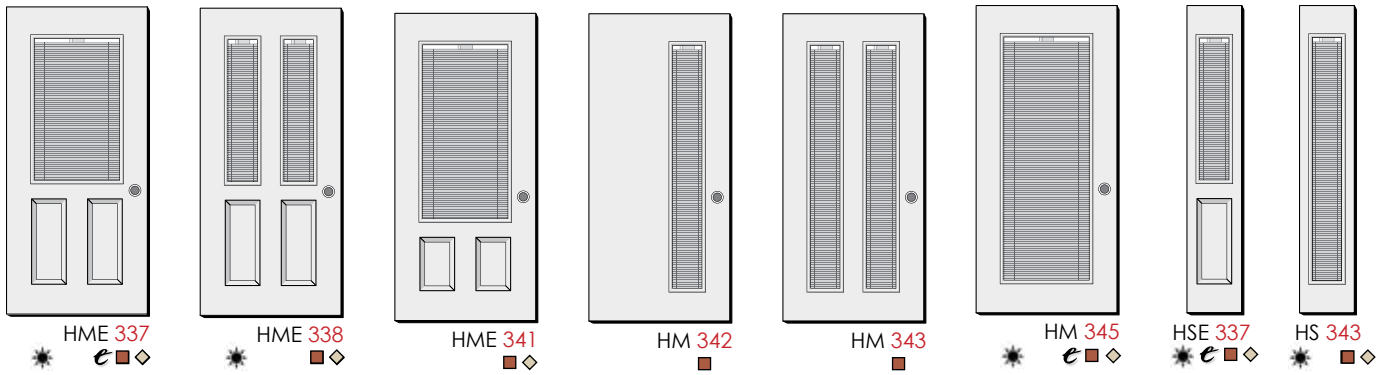

Thermally sealed between two pieces of tempered glass, Internal Blinds combine the privacy and light control of conventional blinds, with a hassle-free internal design requiring no dusting at all. Simply use the top control to tilt through a full 180° rotation or use the side control to raise or lower the blinds. Mini Blinds are available in Low-E glass only.

Note: There is a 1/4" gap between the edge of the blind - left, right and bottom - and the glass trim. This ensures proper operation when raising and lowering the blinds.

MINI BLINDS WITH INTERNAL GRIDS

HM 447 Door in a Patio Configuration ▼

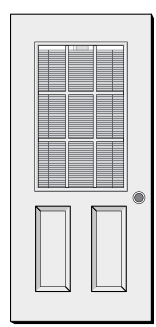

HME 439
* e ■ ◇

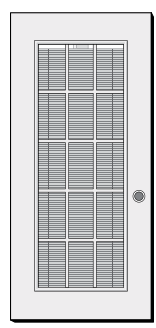

HM 447
* e ■



CUSTOM DOOR OPTIONS:

- R Rain Glass P Pebbled Glass ■ Also Available in Textured Fiberglass
- e Available in Low-E Glass ◇ Also Available with Raised Trim Panels
- * 2011 Stimulus Bill Tax Credit Qualified with Low-E, Low-E Plus and Decorative Glass with coming.

Available in all HMI door styles.

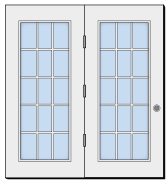

Patio Door Configuration

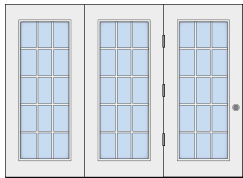
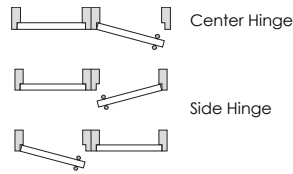

Triple Patio Door Configuration

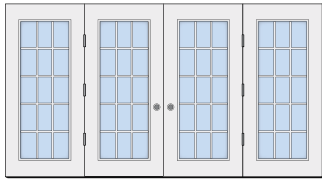
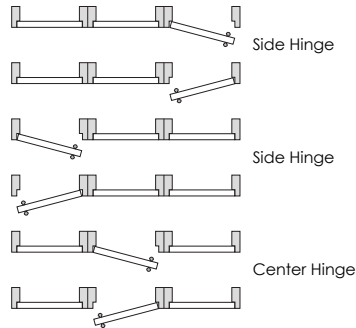

Double Door French Configuration

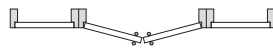

HM 423 Doors in a French Door Configuration ▲

SLIDING SCREEN

Exclusively manufactured by HMI, the Sliding Screen Door features a unique aluminum extruded design ensuring highest quality construction and durability. Unlike other sliding screens where all the weight is placed upon a floor mounted track, HMI's design uses a dual-wheel hung design allowing for a smooth and stress-free operation.

Customers can choose from either a Single Sliding Screen configuration or a Dual Sliding Screen configuration. *(Illustrated to the right)*

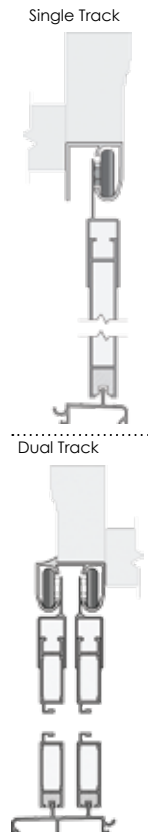

▼ HM 345 Doors in a Patio Configuration ▼



THE SAFEGUARD™ ADVANTAGE

▼ HME 246 Door

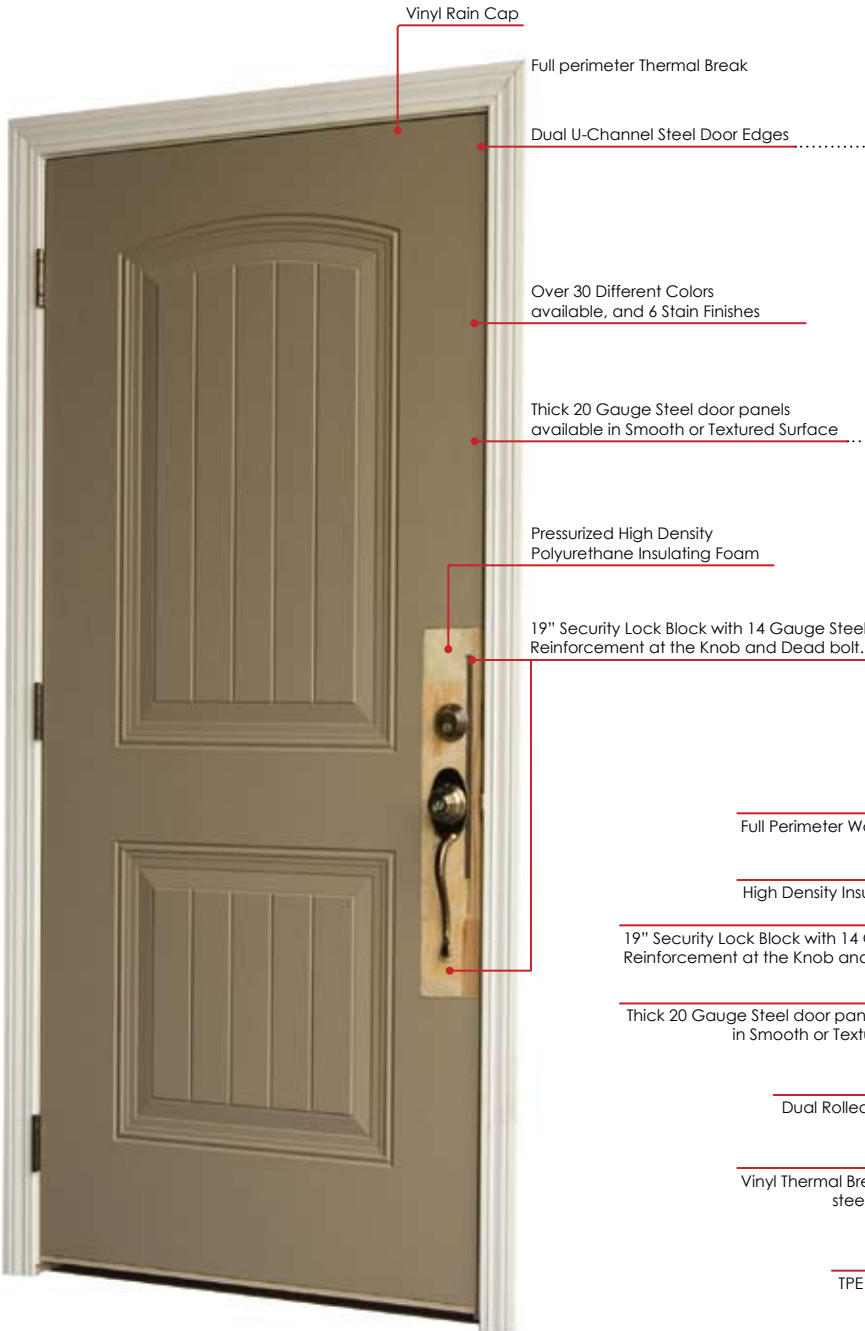

SafeGuard™ steel doors are warranted not to warp, split, shrink, or delaminate for as long as you own your home. *See warranty for additional details.*

The Dual U-Channel Steel Door Edges are custom made to the customer's specific door width instead of the conventional width-cut-down door slab. The 3-Dimensional design provides structural strength against warping and resistance against splitting from break-in attempts. In addition, the full perimeter of the door is sealed with a polymer thermal break providing greater insulation value and preventing any exposed steel edges.

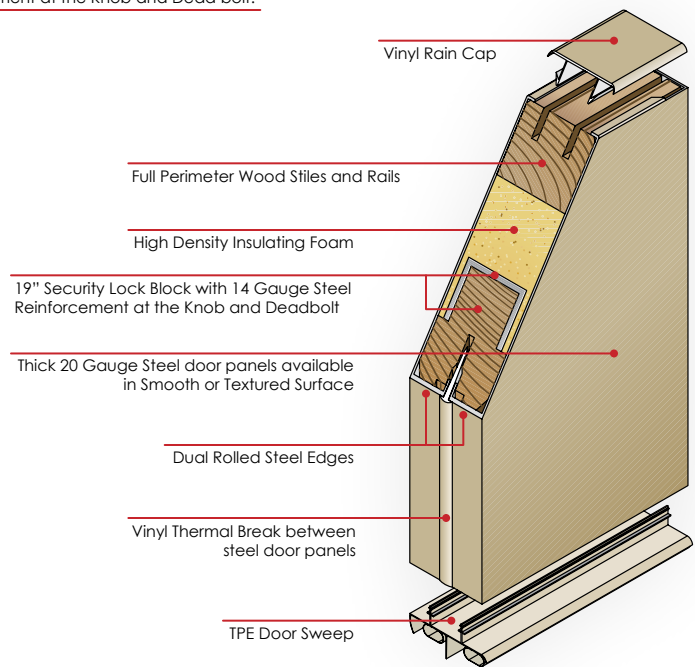

Magnetic Weather-strip for positive air seal along the header and lock side



Q-Lon Weather-strip for compression weather seal along hinge side



Anti-Pry Ball Bearing Hinges
Available in Aged Bronze, Satin Nickel, Polished and Antique Brass

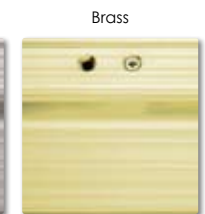

Adjust & Lock Threshold with Thermal Break
Page 8 Price Book

NEW CONSTRUCTION JAMBS

Primed Wood Jamb - Standard

These jambs are vinyl wrapped treated wood for standard sizes: 4 9/16"; 5 1/4"; 6 9/16"; and all other sizes are made of treated wood with aluminum capping. Both vinyl wrapped and aluminum capped jambs are available in smooth and textured surfaces, which can be finished to match the door color. The treated wood underlay is damage resistant to the elements. Whether you have the vinyl wrapped or aluminum capping they are the finishing touch to a sophisticated entrance.

Ultraframe™ Reinforcement - Optional

Page 14 Price Book

Exclusively by HMI our Patented Ultraframe™ allows you to have an elegant entryway with extra security. Each Ultraframe™ has 18 gauge reinforcement steel plates placed behind the deadbolt, knob, and hinges. The steel reinforcement plates are constructed in an "L" shape, which provides strength for a stronger mounting point and resistance against break-ins.

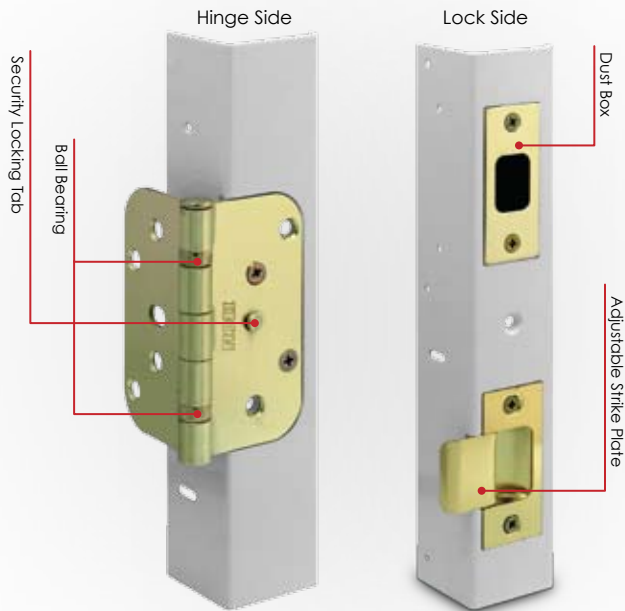
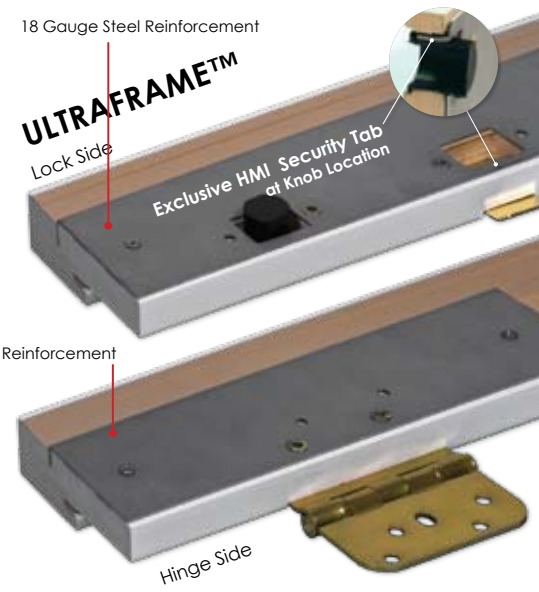

STEEL REPLACEMENT FRAME

Steel Replacement Frames are also available if preferred over a new construction jamb. The frame is constructed of heavy gauge galvanized steel with 10 gauge plates located on the lock and hinge sides for extra reinforcement to help keep intruders out. All replacement frames are finished with a powder coating.



INTERIOR CASING

Interior casing can be painted or stained to match interior decor; supplied primed; or unfinished for customer to finish.

JAMB & FRAME UNIT OPTIONS

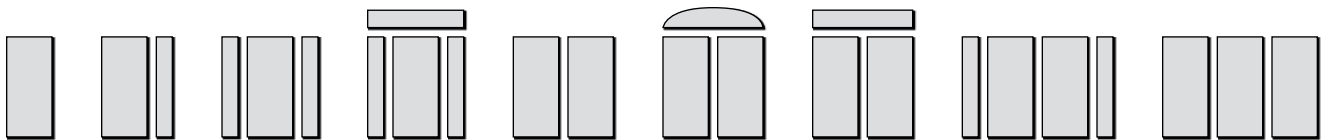

HMI offers an almost endless amount of Jamb & Frame Configurations. Illustrated here are the most common configurations, but customers may order any configuration they choose.

12 POINT LOCKING SYSTEM - #40

Home is our safe shelter

It is a place where we find comfort. It protects our possessions, but more importantly it protects you and your family. Unfortunately, many homes are not as safe as the owner's think:

- Every 14 seconds a home is burglarized.
- More than 50 percent of all residential burglaries, entry is gained through a door.
- High quality 20 gauge steel doors, locks and key control are your first line of defense against a break-in.
- If you have a standard key, it can be copied at any hardware store. Ezcurra security keys can only be duplicated through HMI Doors by using a supplied security key card.
- With Ezcurra you don't have to worry that someone has a key that you don't know about, and who might use it to unlock your door.
- Twelve points of contact, 10 horizontal backsets, 2 vertical backsets
- 10 Gauge steel strike plate the entire length of the lock side
- Anti-pick and anti-drill proof
- Concealed, tamper-proof deadbolts
- Available in replacement and new construction
- Available in doors up to 96" in height
- Available in smooth and textured steel doors
- Locks are factory installed (only handles installed on-site)



Existing unsightly secure door
HMI 12-Point will replace this



4 POINT MORTISE LOCK - #42



▲ HME 246 Door with 4-Point #42

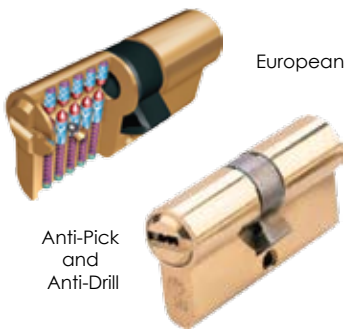

European Cylinders

Anti-Pick and Anti-Drill



Four nickel keys

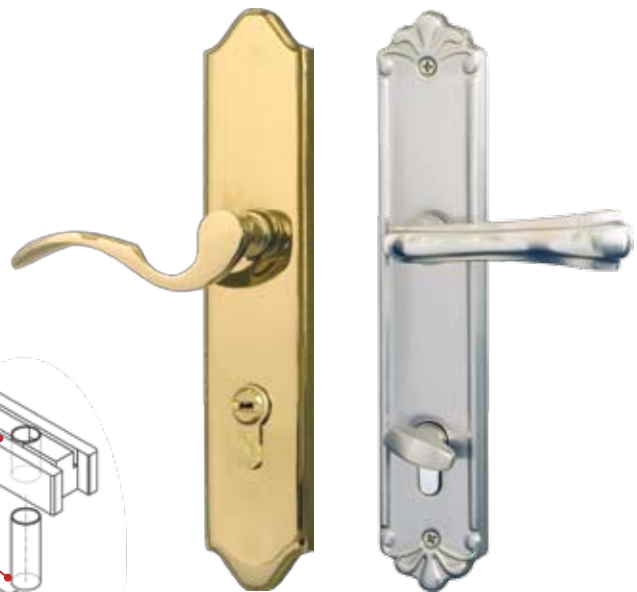

Concord

Petal

Polished Brass

Polished Brass

Satin Nickel

Satin Nickel

Aged Bronze

Aged Bronze

Oil Rubbed handle set available only in polish brass or satin nickel backset plate

4 1/4" Finger joint lock block the entire length of the lock side

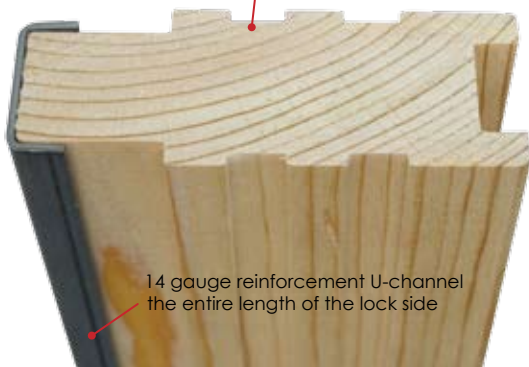

14 gauge reinforcement U-channel the entire length of the lock side

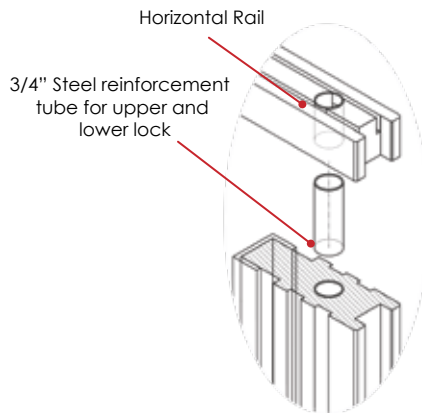

Horizontal Rail

3/4" Steel reinforcement tube for upper and lower lock

Patent Pending

HARDWARE FINISHES



Polished Brass - Lifetime Finish



Antique Brass - 10 Year Finish



Satin Nickel



Aged Bronze

PREMIUM HANDLE SETS Lifetime Finish



Addison #24



Plymouth #25



Interior Georgian Knob



Interior Accent Lever

Interior options for handle sets are the Georgian Knob or the Accent Lever. A B360 Single Cylinder Deadbolt is standard with handle sets.

HMI offers four different hardware finish options:

- Polished Brass
- Satin Nickel
- Antique Brass
- Aged Bronze



Camelot #26



Bowman #27

Standard Handle Sets

Deadbolt Options

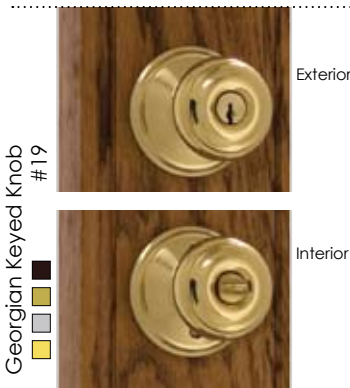

Georgian Keyed Knob #19

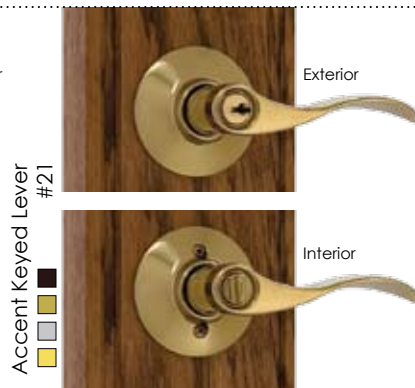

Accent Keyed Lever #21

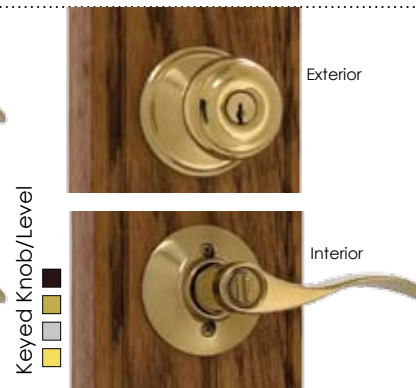

Keyed Knob/Level

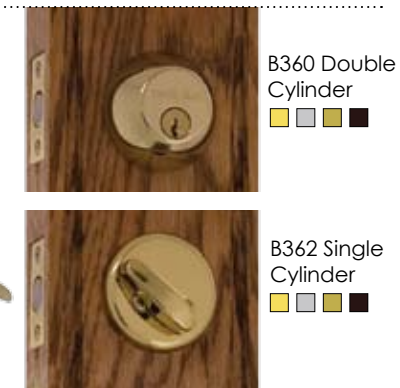

B360 Double Cylinder

B362 Single Cylinder

Accessories



Std Mail Slot - (3 x 10)
Magazine Mail Slot - (3 x 13)

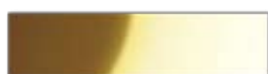

Magnetic Kick Plate

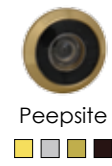

Peepsite



Peek-O Viewer



Knocker



Lifetime Knocker



Peep Knocker



Lifetime Peep Knocker



S Style Knocker



Decor Pitcher Handle

HARDWARE

Mortise Lock: The ideal solution for narrow doors with larger glass.

DISTINCTIVE HANDLE SETS WITH TUBULAR BACKSETS



Ribbon & Reed #30 ■ ■ ■



Wilshire #34 ■ ■ ■



Marietta #32 ■ ■ ■



Mortise Lock #36 ■ Polished Brass ■ Polished Chrome

MORTISE LOCKS WITH SECURITY FEATURES



Regency #54 ■ ■ ■



Manhattan #58 ■ ■ ■



Memphis #56 ■ ■ ■



Salem #52 ■ ■ ■



Jackson #50 ■ ■ ■

Interior Handle Options

#30, #32, #34, #50, #52, #54, #56, #58



Egg Knob



Wembley Lever



Cortina Lever

KEYLESS ENTRY



Digital Single Cylinder Deadbolt #28

■ ■ ■

- Deadbolt is available with any Schlage entry hardware
- Lighted keypad
- 9-volt battery included
- Add up to 19 user codes
- Easy to add or delete codes

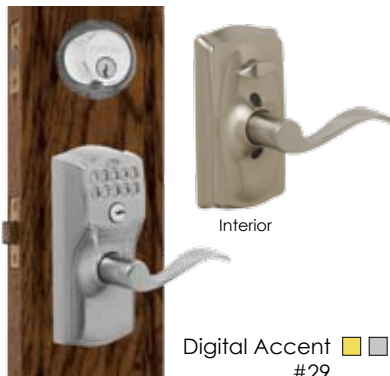

Digital Accent #29

■ ■ ■

EZ SET



Exterior



EZ Set Single ■ ■ ■



Interior



EZ Set Double Cylinder #5 ■ ■ ■ 39

FRENCH SIDELITES

FRENCH SIDELITES



French Sidelites work just like our Double Doors to provide you with another innovative option.

Hinged on opposite sides of the jamb, French Sidelites allow for the sidelite and door to be opened simultaneously, providing a wider entryway opening.

Enjoy the beauty of a classic door and sidelite with the practical space to move household appliances and furniture through.

◀ HME 258N Door and HS 242N Sidelite ▶



HMI QUICK SHIP DOORS

Available in 5 business days or less – Guaranteed! Quick ship doors are painted white, are inswing and have a steel replacement frame. They are constructed of smooth 20 gauge steel with clear glass, and polished hinges. Available sizes are listed below each style Quick Ship door.

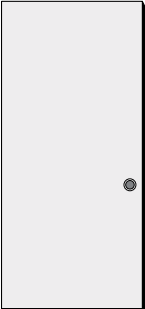
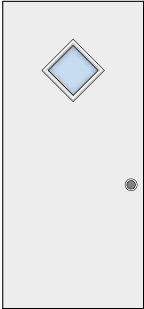
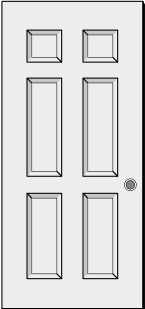
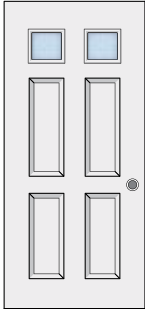
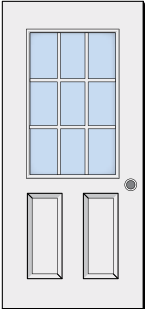
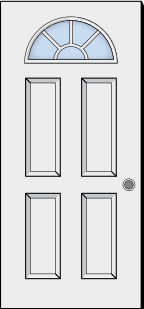
		Embossed Panels	Embossed Panels	Embossed Panels and External Grid	Embossed Panels and External Grid
					
★ HM 202Q	★ HM 206Q	★ HME 220Q	★ HME 222Q	HME 313Q	★ HME 301Q
28 x 80"	28 x 80"	30 x 80"	30 x 80"	30 x 80"	30 x 80"
30 x 80"	30 x 80"	32 x 80"	32 x 80"	32 x 80"	32 x 80"
32 x 80"	32 x 80"	36 x 80"	36 x 80"	36 x 80"	36 x 80"
36 x 80"	36 x 80"				