

LASTING ELEGANCE

ENTRY AND ALUMINUM STORM DOORS 2011

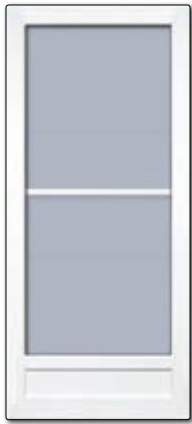

SELF-STORING GLASS



HM 607



HM 608



HM 609



HM 610

- Two moveable glass panels operate independently from top, bottom or both
- Glass frame designed to stay on track
- Nylon guide for smooth operation
- Removable screen

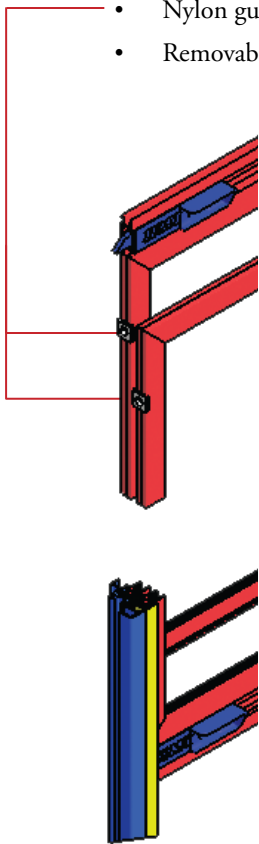

DOGGY DOOR

We have not forgotten your best friends. A pet door can be added to HM 605, 606, 609, 610 flush bottom doors.



G/GROOVE

GROOVED GLASS



HM 602M Storm Door with Satin Nickel Kick Panel ▲

Grooved glass has geometrically carved bevels that add a classic touch of beauty to your storm door's appearance. Choose between the HM-G series or the HM-M series grooved glass.



OVERLAYS/S

OVERLAY CAMING GLASS

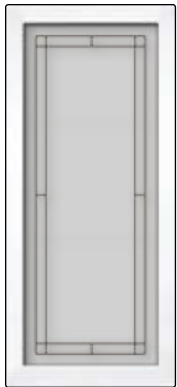

HM 601L



HM 602L



HM 603L

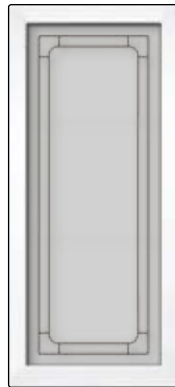

HM 601P

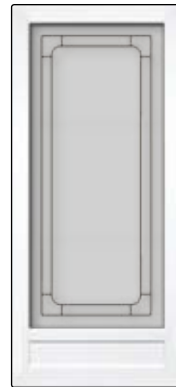

HM 602P

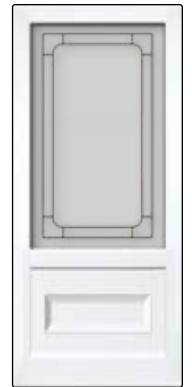

HM 603P

Available in Polished Brass or Satin Nickel caming

In addition to grooved glass, HMI also offers two overlay caming glass styles. A simple addition to your storm door's glass can make a great difference in the way it presents itself. Choose either the HM-L series for a contemporary look or the HM-P for a bit of elegance. **Both styles are available in Polished Brass and Satin Nickel caming.**

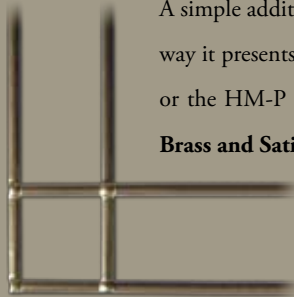

HM-L

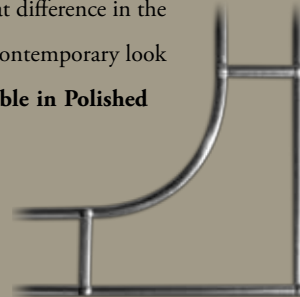

HM-P

EXPANDABLE FRAME

Expandable Z-Bar

With Brick Moulding



Expandable Z-Bar

No Brick Moulding

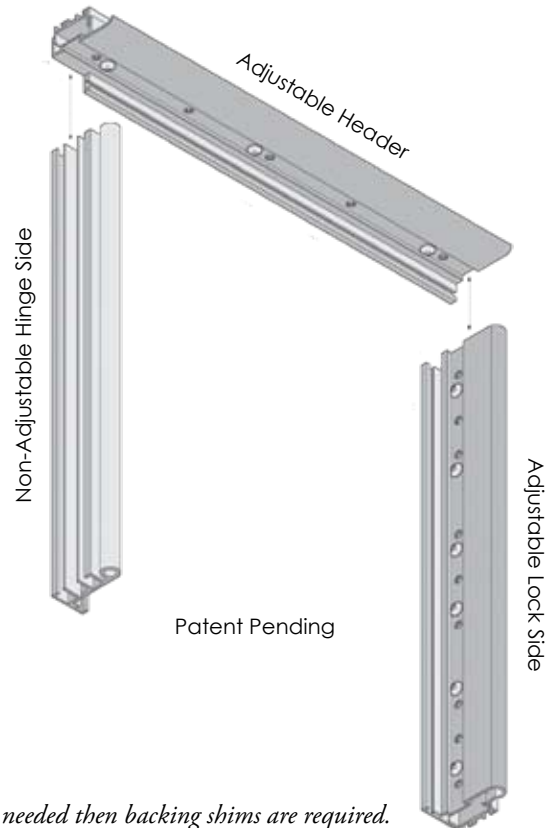
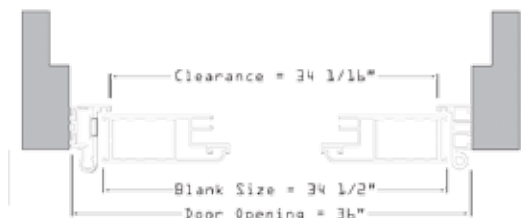

Extruded Aluminum Corner Bracing System

HMI takes durability to the next level by introducing a specially reinforced aluminum corner gusset system, adding a .65" thick high grade aluminum walls, and making a number of design enhancements as well as supplying the heaviest gauge aluminum offered by any door manufacturer resulting in a stable door that resists twisting and denting.

19 powdercoat colors to match entry door and over 200 custom colors to choose from

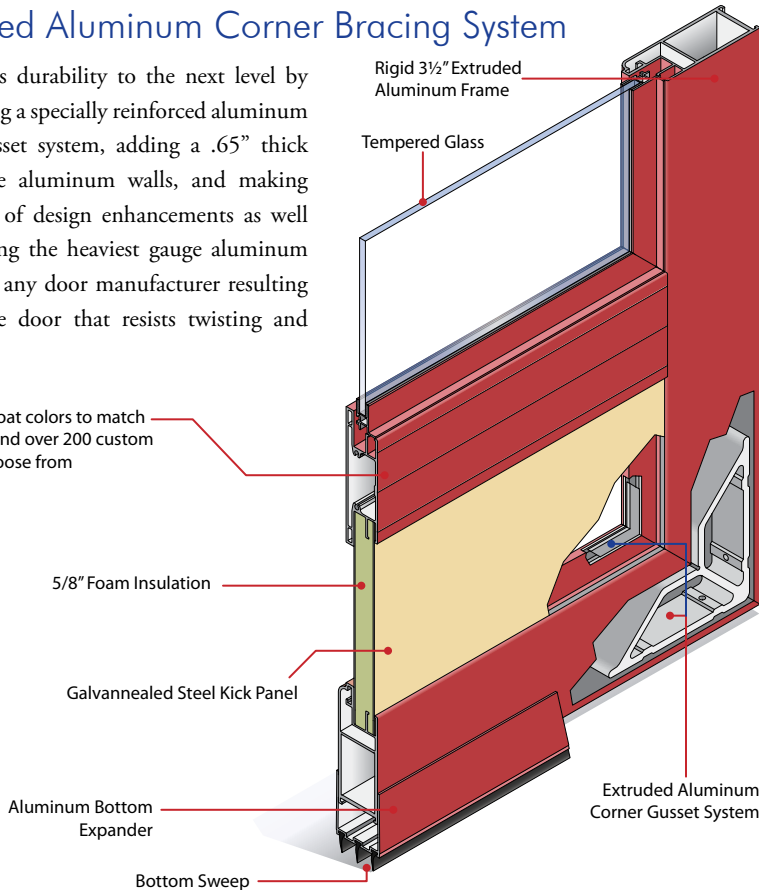

Heat Ventilation System - Optional

Another feature offered by HMI is the Storm Door Heat Ventilation system. Occasionally heat becomes trapped in between the storm door and entry door leading to condensation build-up or damage to the entry door's paint finish. However, with the help of our Heat Ventilation system, the hot air is given a path to exit. On the top edge of the storm door, as illustrated below, are a series of holes and a vent cap that can be opened during the summer and closed during the winter.

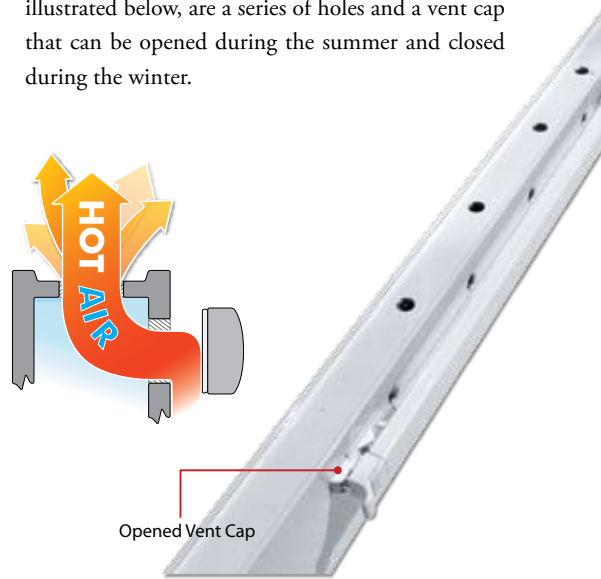

Cam Lock System

Offered exclusively by HMI, the Patent Pending Cam Lock System is one of the Elite Storm Doors innovations. Other cam lock designs, offered by the competition, use hand tightened screws along with various plastic pieces that may break or come loose over the years. HMI's Cam Lock System is free of loose parts and accessories, giving the homeowner problem free operation.



All the hardware is hidden inside the door, making it hassle-free to replace your screen. One quick turn to loosen and another one to tighten!

Aluminum Extruded Hinges

Continuous Extruded Hinges, manufactured exclusively by HMI, surpass the quality and durability of anything else offered on the market. Extending from top to bottom, and reinforced with a stainless steel rod, our Extruded Hinges will never sag or warp from the weight of the door. Thus ensuring a perfect fit every time you close your Storm Door.



HARDWARE

PULL HANDLES



Satin Nickel #6 Brass #6 White #6 Black #6 Aged Bronze #6



2" x 10" Mail Slot



3" x 13" Magazine Slot



Kick Panel (Only for HM 602 & HM 603)



Bottom Aluminum Expander
Std - Painted to match your storm door.



SCULPTED LEVERS

Left Hinge Out Swing Door



Satin Nickel #7

Brass #7

Right Hinge Out Swing Door



White #7

Black #7

Aged Bronze #7

ELITE LEVERS



Brass #8

Satin Nickel #8

Aged Bronze #8



Slimline Lock #3



Door Closers are painted to match your storm door.

Polished Brass
 Antique Brass
 Satin Nickel
 Aged Bronze

Note: Only #3 lock can be keyed to your entry door.

PAINT, POWDERCOAT AND STAINS

Paint (P - Matching Powder Coat finish for Aluminum and Security Storm doors)



X Textured Recommended

Stain Finishes (For Entry Doors Only)



Note: These sample colors do not accurately reflect actual painted/stained or powdercoated surface colors due to limitations in the printing process. Please see your sales representative for HMI color chips.

All 20 gauge **HMI** steel entry doors are galvanized to A40 and chem treated to prevent rusting. **HMI** steel and fiberglass doors are first primed with a durable undercoat that is oven-cured for lasting resiliency.

Paint - A final paint finish is applied to the doors and oven-cured a second time forming an enduring lustrous look.

Stain - Hand applied to give a wood grain appearance, it is then top coated with a 2-part clear urethane protective coat with a UV inhibitor. It is then oven-cured a second time forming an enduring lustrous look.

Powdercoat - Aluminum and security storm doors are chem washed then oven dried. The powdercoating is electrostatically applied and double baked to create a durable resilient finish. Powdercoats have a glossier sheen than do paints.

* Due to possible heat buildup, the warranty for entry doors does not apply to the door or glass trim painted in these colors when installed behind storm doors.

** Trim color only



BE SURE TO ALSO LOOK AT OUR **SECURITY DOOR CATALOG**

Distributed by:



www.hmidoors.com
Copyright © 2011 Household Metals, Inc.
SafeGuard™ is a trademark of Household Metals, Inc.