

LASTING ELEGANCE

ENTRY AND ALUMINUM STORM DOORS 2010



LASTING ELEGANCE ENTRY DOORS

Lasting Elegance - begins with **SafeGuard™** Customer satisfaction is exactly what we deliver at Household Metals Inc. Homeowners looking to purchase a new door find that we set the industry standard for custom, top of the line home entryways. Each door produced by our assembly line comes with the **SafeGuard™** Advantage, which promises our customers a high quality entry door guaranteed not to rust, shrink, split, or delaminate.

Our advanced production facilities make HMI one of the few companies that manufacture doors according to customer specifications. We are a make-to-order company treating each door as a custom door whether it is a standard size or not. We offer the most secure door on the market because our 19" lock block has a 14 gauge steel reinforcement channel along with a 20 gauge steel door skin. This combination offers 40% more protection than home center doors. The **SafeGuard™** Advantage can provide your home with beauty, security, and the guarantee of a lifetime.

DOOR STYLES

HMI is the one-stop-shop for all your entryway door needs whether it's our Fiberglass or Steel Entry Doors, Aluminum Storm Doors, Security Storm Doors or an entryway with a custom arch top. With over 80 available door styles, **SafeGuard™** entry doors can accommodate all customer needs and wants.

GLASS STYLES

HMI offers a comprehensive collection of decorative glass for doors, sidelites, and transoms. By purchasing our glass from 4 major glass suppliers, it allows us to offer our customers an extensive selection.

VARIETY

HMI doors are designed to the highest standards of energy efficiency, security, and sturdiness without sacrificing beauty. All of our entry doors are available in: steel - textured and smooth finishes; and fiberglass - in textured only. Made to enhance your entryway and satisfy your unique taste, we offer a variety of rich colors with a vast selection of glass styles.

ELITE STORM DOORS

HMI's *Elite Series* embraces balance and proportion while using durable design concepts and long lasting materials. *Elite* is all about providing comfort, light, distinction, and value.

DOOR STYLES

With ten distinctive styles to choose from your preference is always met. Whether it is a classic full view or convenient self-storing storm door you get what you want.

GLASS STYLES

With traditional clear glass, grooved glass and glass with coming you can choose the look that fits your style.



DECORATIVE AND CLEAR GLASS STYLES

- 4** HEIRLOOM - N, NS
- 6** TAJ - K, KS
- 8** EMBASSY - Y, YS
- 10** PANAMA - P, PS
- 12** SMOKED - Z
- 13** PARIS - X
- 14** GEORGIAN - A, AS, AP
- 16** ALSTON - T
- 17** ELAN - Q
- 18** CADENCE - CA
- 19** WINSLOW - C, CS
- 20** ORNAMENTAL GLASS - TF, TC, RO, VE
- 21** RIVIERA - L
- 22** FANLITES/CAMBER TOP - Z, ZS, L, N, NS, D, G, GS, B, BS, H, HS, I, IS, M, MS, E, ES, JS
- 24** PHOTO GALLERY
- 26** ONE LITE (GLASS WITHOUT GRIDS)
- 28** EXTERNAL GRIDS
- 29** INTERNAL GRIDS
- 30** MINI BLINDS
- 31** PATIO DOORS WITH SLIDING SCREEN
- 32** FIBERGLASS DISTINCTIVE COLLECTION

SAFEGUARD™ OPTIONS

- 34** THE SAFEGUARD™ ADVANTAGE
- 35** JAMB & FRAMING OPTIONS
- 36** 12 POINT LOCK
- 37** 4 POINT LOCK
- 38** HARDWARE
- 40** FRENCH SIDELITES QUICKSHIP

STORM DOORS

- 41** ELITE STORM DOORS
- 42** GROOVED GLASS
- 43** OVERLAY CAMING
- 44** SELF-STORING
- 45** HMI ENGINEERING/CAM LOCK EXTRUDED HINGE & HEAT VENT
- 46** HARDWARE
- 47** PAINT POWDER COAT STAIN

BACK COVER SECURITY DOOR

HEIRLOOM

HEIRLOOM

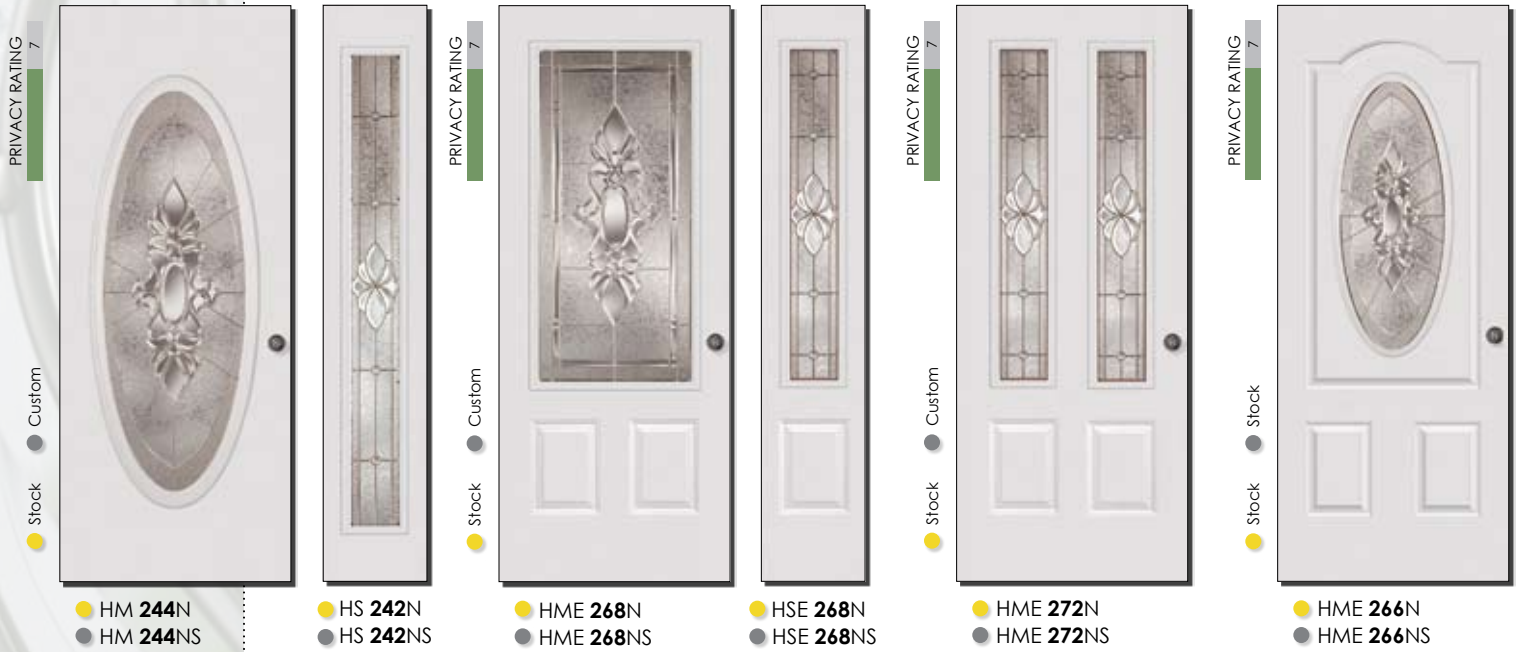

● HME 262N Door and HT 200 Transom ▼

Each glass style has a stock and custom caming style denoted by a colored dot - yellow ● for Brass and gray ● for Satin Nickel.





PRIVACY RATING 7

● Stock ● Custom



● HME 218N
● HME 218NS

PRIVACY RATING 7

● Custom ● Stock



● HME 239N
● HME 239NS

PRIVACY RATING 7

● Stock ● Custom



● HME 238N
● HME 238NS

● HM 242N Door, ● HS 242N Sidelites and ● HT 200N Transom ▲

PRIVACY RATING 7

● Stock ● Custom

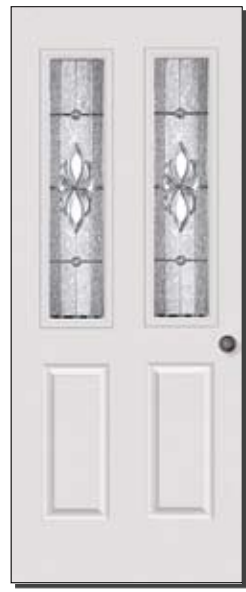

● HME 230N
● HME 230NS

PRIVACY RATING 7

● Custom ● Stock



● HME 284N
● HME 284NS



● HSE 268N
● HSE 268NS

PRIVACY RATING 7

● Custom ● Stock

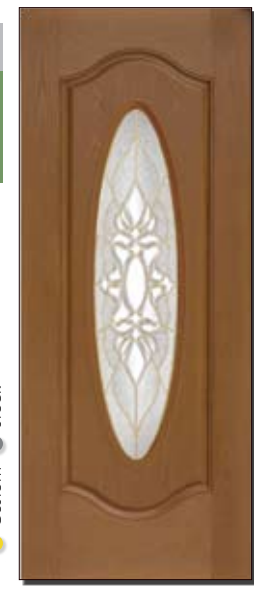

● HME 276N
● HME 276NS

GRANITE
CLEAR BEVEL
CLEAR GLUE CHIP



GLASS DETAIL

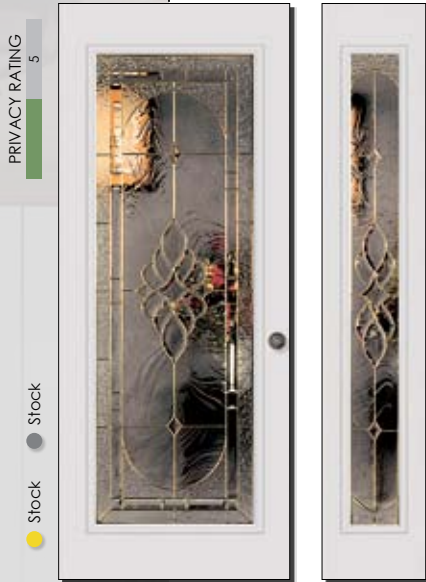

● HM 242K
● HM 242KS



● HS 242K
● HS 242KS



● HME 268K
● HME 268KS



● HSE 268K
● HSE 268KS

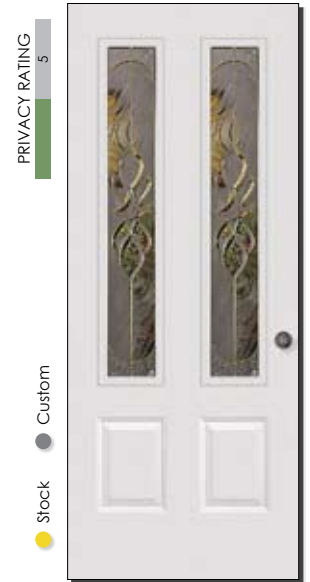

● HME 272K
● HME 272KS

● HME 238K Door ▼

Each glass style has a stock and custom caming style denoted by a colored dot - yellow ● for Brass and gray ● for Satin Nickel.

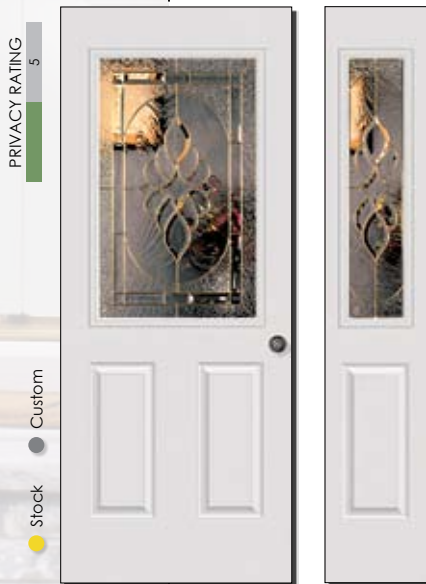

● HME 224K
● HME 224KS



● HSE 224K
● HSE 224KS

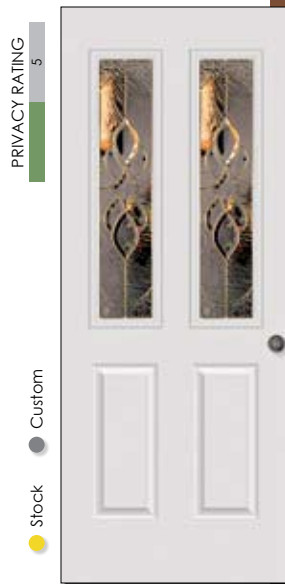

● HME 230K
● HME 230KS



PRIVACY RATING
5



● Stock
● Custom

- HME 226K
- HME 226KS



● HME 248K Door ▲

CLEAR
GLUE CHIP

CLEAR BEVEL

CLEAR
BAROQUE



GLASS DETAIL



- HT 200K
- HT 200KS



- HT 230K
- HT 230KS

PRIVACY RATING
5



● Stock
● Custom

- HME 266K
- HME 266KS

PRIVACY RATING
5



● Stock
● Custom

- HME 258K
- HME 258KS

PRIVACY RATING
5



● Stock
● Custom

- HME 218K
- HME 218KS

EMBASSY

EMBASSY

PRIVACY RATING
5



● Stock
● Custom

● HM 244Y
● HM 244YS



● HS 242Y
● HS 242YS

PRIVACY RATING
7

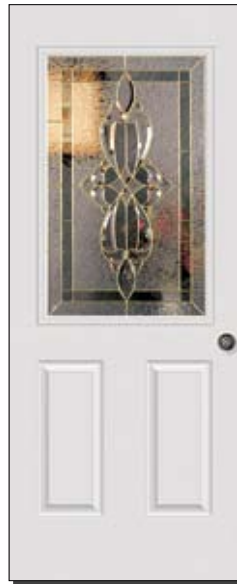

● Stock
● Custom

● HME 224Y
● HME 224YS



● HSE 224Y
● HSE 224YS

PRIVACY RATING
7



● Stock
● Custom

● HME 230Y
● HME 230YS

Each glass style has a stock and custom coming style denoted by a colored dot - yellow ● for Brass and gray ● for Satin Nickel.

● HME 238Y Door and ● HS 242Y Sidelite ▼

PRIVACY RATING
7



● Stock
● Custom

● HME 266Y
● HME 266YS



● HSE 268Y
● HSE 268YS





GRAY BAROQUE
CLEAR BEVEL
CLEAR GLUE CHIP

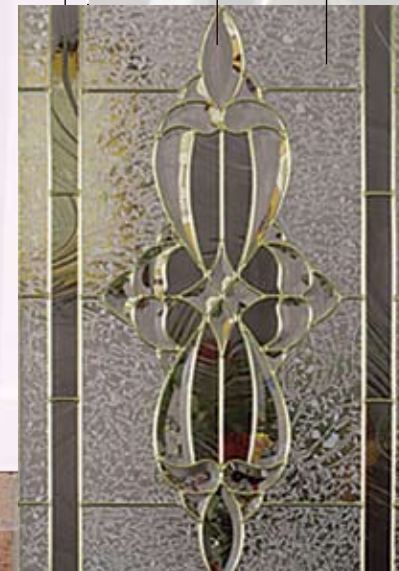

GLASS DETAIL

● HME 258Y Door ▲



● HT 200Y ● HT 200YS



● HT 230Y ● HT 230YS

PRIVACY RATING
7

● Stock
● Custom



● HME 268Y
● HME 268YS



● HSE 268Y
● HSE 268YS

PRIVACY RATING
7

● Stock
● Custom



● HME 272Y
● HME 272YS

PRIVACY RATING
7

● Stock
● Custom

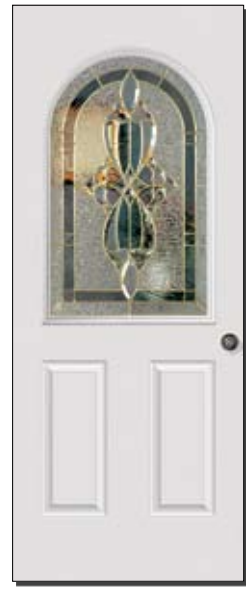

● HME 226Y
● HME 226YS

PANAMA

PANAMA

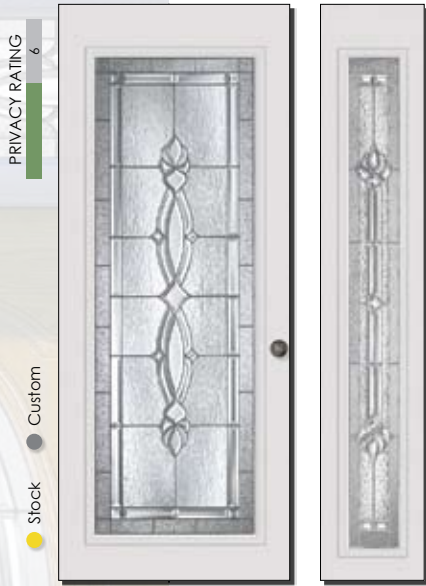

● HM 242P
● HM 242PS

● HS 242P
● HS 242PS



● HME 284P
● HME 284PS

● HSE 268P
● HSE 268PS



● HME 272P
● HME 272PS

Each glass style has a stock and custom coming style denoted by a colored dot - yellow ● for Brass and gray ● for Satin Nickel.



● HME 224P
● HME 224PS

● HSE 224P
● HSE 224PS

● HME 266PS Door, ● HSE 268PS Sidelites and ● HT 200PS Transom ▼





● HME 226PS Door, ● HS 242PS Sidelites and ● HT200PS Transom▲

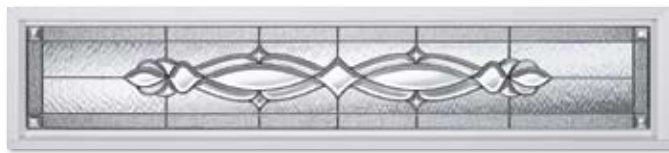
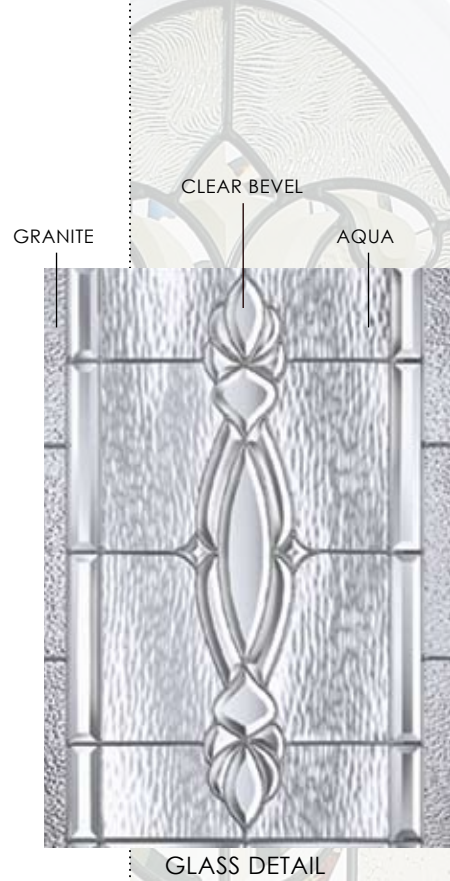

● HT 200P ● HT 200PS



● HT 230P ● HT 230PS



● HME 230P
● HME 230PS



● HME 258P
● HME 258PS

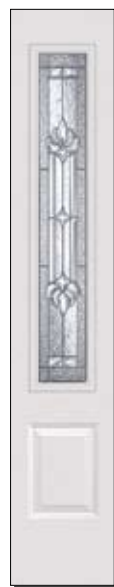

● HSE 268P
● HSE 268PS



● HME 268P
● HME 268PS



● HSE 268P
● HSE 268PS

SMOKED

SMOKED

PRIVACY RATING 7



● HM 242Z

● Brass Carving Only - Stock

PRIVACY RATING 7



● HS 242Z

● Brass Carving Only - Stock

PRIVACY RATING 7



● HM 244Z

● Brass Carving Only - Stock



● HS 242Z



● HT 200Z



● HT 230Z

CLEAR BEVEL

CLEAR GLUE CHIP

GRAY WATERGLASS



GLASS DETAIL

● HM 242Z Door ▼

PRIVACY RATING 7



● HME 218Z

● Brass Carving Only - Stock



PARIS

PARIS

Each glass style has a stock and custom coming style denoted by a colored dot - yellow ● for Brass and black ● for Black Patina.

PRIVACY RATING 6

● Black Patina Coming Only - Stock



● HME 224X



● HSE 224X

PRIVACY RATING 6

● Black Patina Coming Only - Stock



● HME 230X

PRIVACY RATING 6

● Black Patina Coming Only - Stock



● HME 268X



● HSE 268X

● HME 307X Door and ● HS 242X Sidelites ▼



GLASS DETAIL

PRIVACY RATING 6

● Black Patina Coming Only - Stock



● HM 242X



● HS 242X

GEORGIAN

GEORGIA

PRIVACY RATING 7

● Custom ● Stock



- HM 242A
- HM 242AS

- HS 242A
- HS 242AS

PRIVACY RATING 7

● Custom ● Stock



- HME 258A
- HME 258AS
- HME 258AP

PRIVACY RATING 7

● Custom ● Stock



- HME 266A
- HME 266AS
- HME 266AP

● HM 244AS Door and ● HS 242AS Sidelites ▼

CLEAR BEVEL
CLEAR GLUE CHIP

PRIVACY RATING 7

● Custom ● Stock



- HME 226A
- HME 226AS
- HME 226AP



GLASS DETAIL

Each glass style has a stock and custom caming style denoted by a colored dot - yellow ● for Brass, gray ● for Satin Nickel and black ● for Black Patina.



- HME 268A
- HME 268AS
- HME 268AP
- HSE 268A
- HSE 268AS
- HSE 268AP



- HME 272A
- HME 272AS
- HME 272AP
- HSE 272A
- HSE 272AS
- HSE 272AP



- HME 254A
- HME 254AS
- HME 254AP
- HSE 224A
- HSE 224AS
- HSE 224AP



- HT 230A
- HT 230AS
- HT 230AP



- HT 200A
- HT 200AS
- HT 200AP



- HME 230A
- HME 230AS
- HME 230AP



- HME 218A
- HME 218AS
- HME 218AP



- HME 307A
- HME 307AS
- HME 307AP



- HME 238A
- HME 238AS
- HME 238AP

GLASS DETAIL



CLEAR BEVEL

TEMPERED SURF GLASS

GRANITE



PRIVACY RATING 7

● Antique Black Caming Only - Custom

● HME 224T

PRIVACY RATING 7

● Antique Black Caming Only - Custom

● HSE 224T

PRIVACY RATING 7

● Antique Black Caming Only - Custom

● HME 230T

PRIVACY RATING 7

● Antique Black Caming Only - Custom

● HME 307T

Each glass style has a stock and custom caming style denoted by a colored dot - black ● for Antique Black or Black Chrome.

● HME 268T Door and ● HSE 268T Sidelites ▼



PRIVACY RATING 7

● Antique Black Caming Only - Custom

● HME 266T



PRIVACY RATING 7

● Antique Black Caming Only - Custom

● HME 258T



PRIVACY RATING 8

● Black Chrome Coming Only - Custom



● HM 242Q



● HS 242Q

PRIVACY RATING 8

● Black Chrome Coming Only - Custom



● HME 268Q

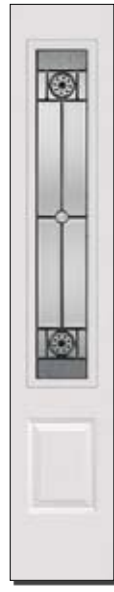

● HSE 268Q

PRIVACY RATING 8

● Black Chrome Coming Only - Custom



● HME 307Q

● HM 242Q Door and ● HS 242Q Sidelites ▼



CLEAR WATERGLASS

CLEAR BEVEL

BLACK & CHROME MEDALLION

GRAY WATERGLASS

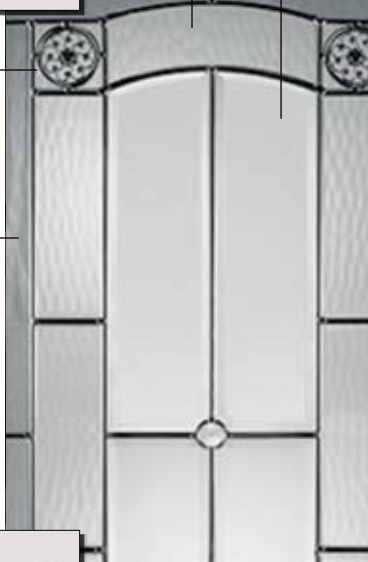

GLASS DETAIL

PRIVACY RATING 8

● Black Chrome Coming Only - Custom



● HME 272Q

CADENCE

CADENCE

PRIVACY RATING
6

● Black Patina Caming Only - Custom



● HME 258CA

PRIVACY RATING
6

● Black Patina Caming Only - Custom



● HME 266CA

PRIVACY RATING
6

● Black Patina Caming Only - Custom



● HME 268CA



● HSE 268CA

PRIVACY RATING
6

● Black Patina Caming Only - Custom



● HM 244CA



● HS 242CA

● HM 242CA Door ▼



● HT 230CA



RIPPLE CLEAR BEVEL HAMMERED



GLASS DETAIL

PRIVACY RATING
7

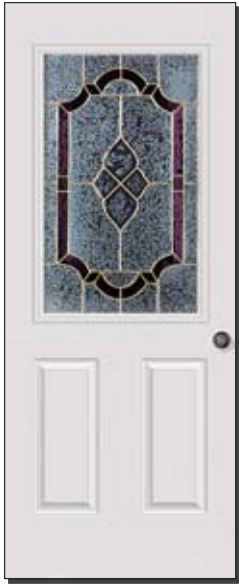

● Stock
● Custom

● HME 224C
● HME 224CS

● HSE 224C
● HSE 224CS

PRIVACY RATING
7



● Stock
● Custom

● HME 268C
● HME 268CS

● HS 242C
● HS 242CS

CLEAR
GLUE CHIP

CRANBERRY



GLASS DETAIL

● HME 258C Door and ● HSE 242C Sidelites ▼

PRIVACY RATING
7

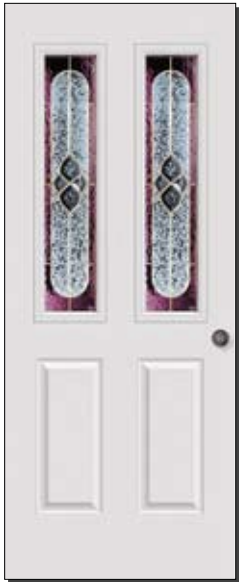

● Stock
● Custom

● HME 230C
● HME 230CS

PRIVACY RATING
7

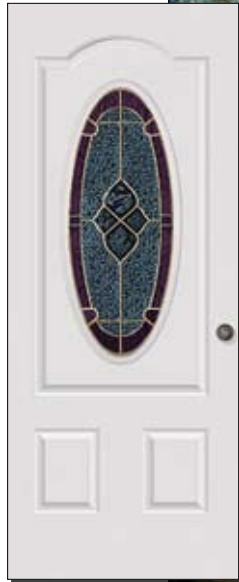

● Stock
● Custom

● HME 266C
● HME 266CS



Each glass style has a stock and custom coming style denoted by a colored dot - yellow ● for Brass, gray ● for Satin Nickel, and black ● for Black Patina.

ORNAMENTAL GLASS

HMI's Ornamental Glass Collection combines **SafeGuard™** innovation and the classic look of Wrought Iron Designs. Each glass style is made of Black Wrought Iron and comes with your choice of frosted glass to ensure superior security and privacy or clear glass.



FROSTED

GLASS DETAIL

10
PRIVACY RATING

● Wrought Iron - Stock



● HME 254TF

● HSE 224TF

10
PRIVACY RATING

● Wrought Iron - Stock



● HME 266RO

● HSE 268RO

10
PRIVACY RATING

● Wrought Iron - Stock



● HME 268TF

● HSE 268TF

● HME 268VE Door and ● HS 242RO Sidelites ▼

● HM 242TC Door ▼





● HME 226L Door and ● HSE 232L Sidelites ▲



Each glass style has a stock and custom caming style denoted by a colored dot - yellow ● for Brass and black ● for Wrought Iron.



GLASS DETAIL

FANLITE/CAMBER TOP GLASS

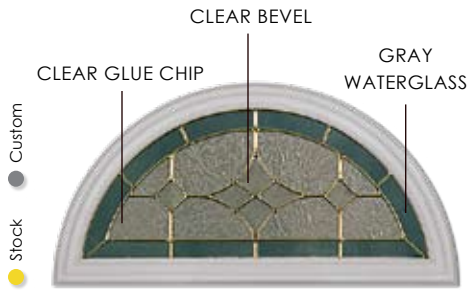

● HME 218Z ● HME 218ZS

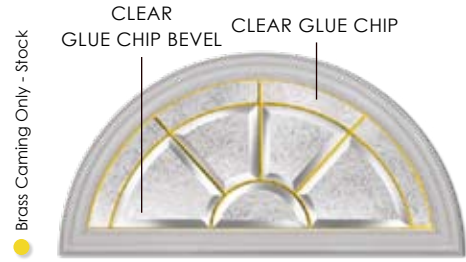

● HME 218L

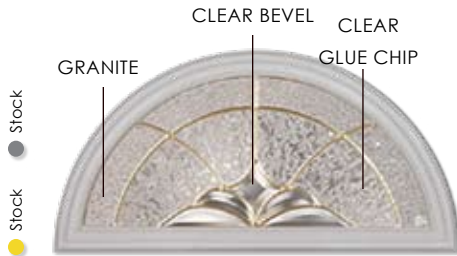

● HME 218N ● HME 218NS

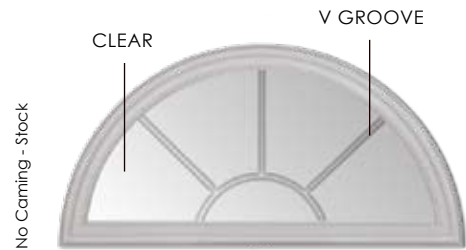

HME 218D

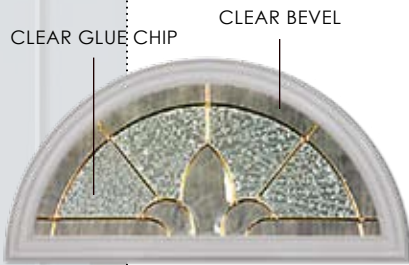

● HME 218G ● HME 218GS



● HME 218B ● HME 218BS

● HME 218N Door and ● HSE 224N Sidelites ▼

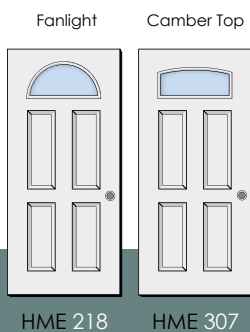

HME 218

HME 307



● HME 307NS Door ▲

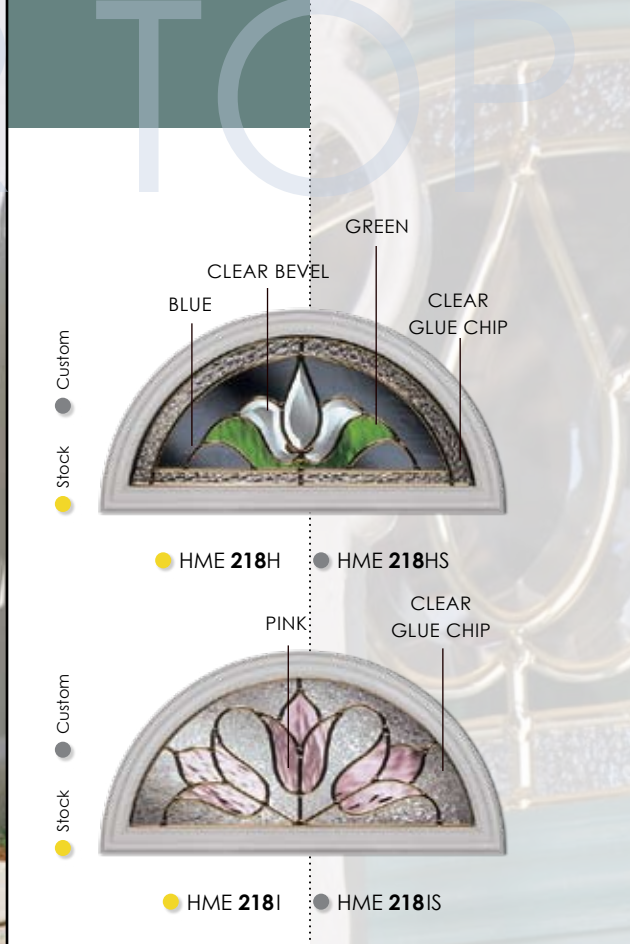

Beautifully trimmed with Brass or Satin Nickel caming these Fanlight/Camber Top styles add beauty and elegance to your entryway. Each glass style has a stock and custom caming style denoted by a colored dot - yellow ● for Brass and gray ● for Satin Nickel.

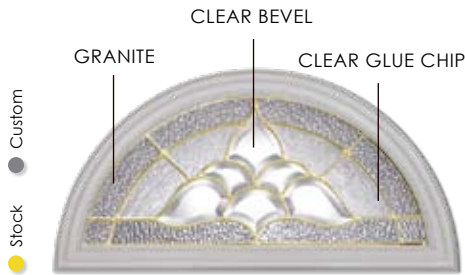

● HME 218M ● HME 218MS

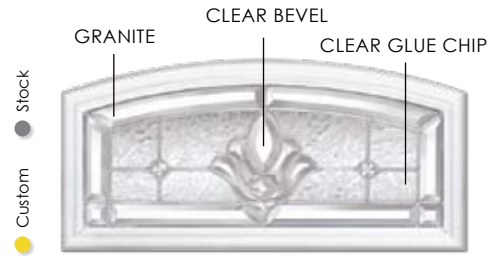

● HME 307N ● HME 307NS

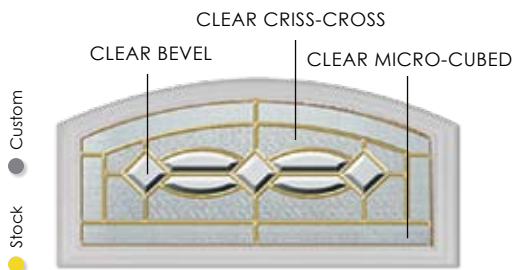

● HME 307E ● HME 307ES

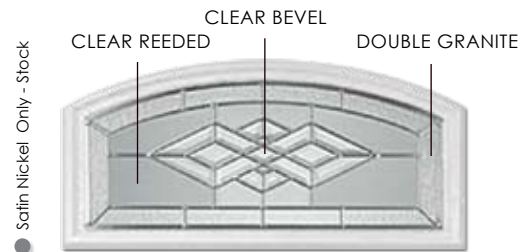

● HME 307JS



HM 348 Door, HS 348 Sidelites and HT230 Transom ▼



HME 246 Door and HS 242NS Sidelites ▼

HM 90 Door with Raised Panels and HS 242AS Sidelites ▼



HM 288 Door with Raised Trim, In and Out, HS 242B Sidelites and HT 200B Transom ▼



HM200 SERIES • ONE LITE STYLES

All HM200 Series Doors & Sidelites are available in Textured or Smooth Steel



◀ HM 242 Door with Rain Glass

CUSTOM ARCH TOP STYLES

Customers can choose from a variety of shapes to fit their home's decor, ranging from a Full Arch to a Cathedral Top. Each arch top door is made to the customer's specific doorway. Please refer to the icons on top of each door style for available and matching arch tops.

Full Arch Camber Top Curved Top Pointed Top Cathedral Top

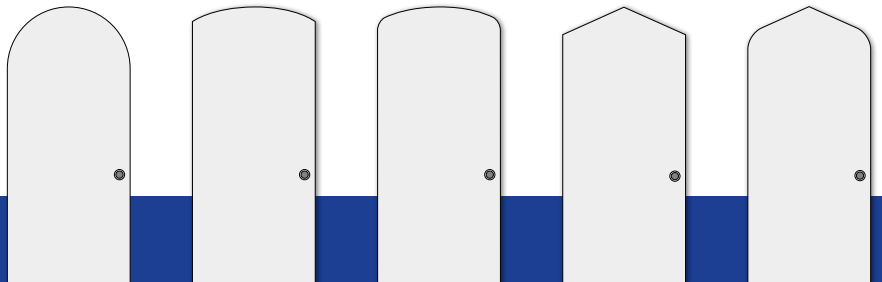

HM200 SERIES • ONE LITE STYLES

All HM200 Series Doors & Sidelites are available in Textured or Smooth Steel

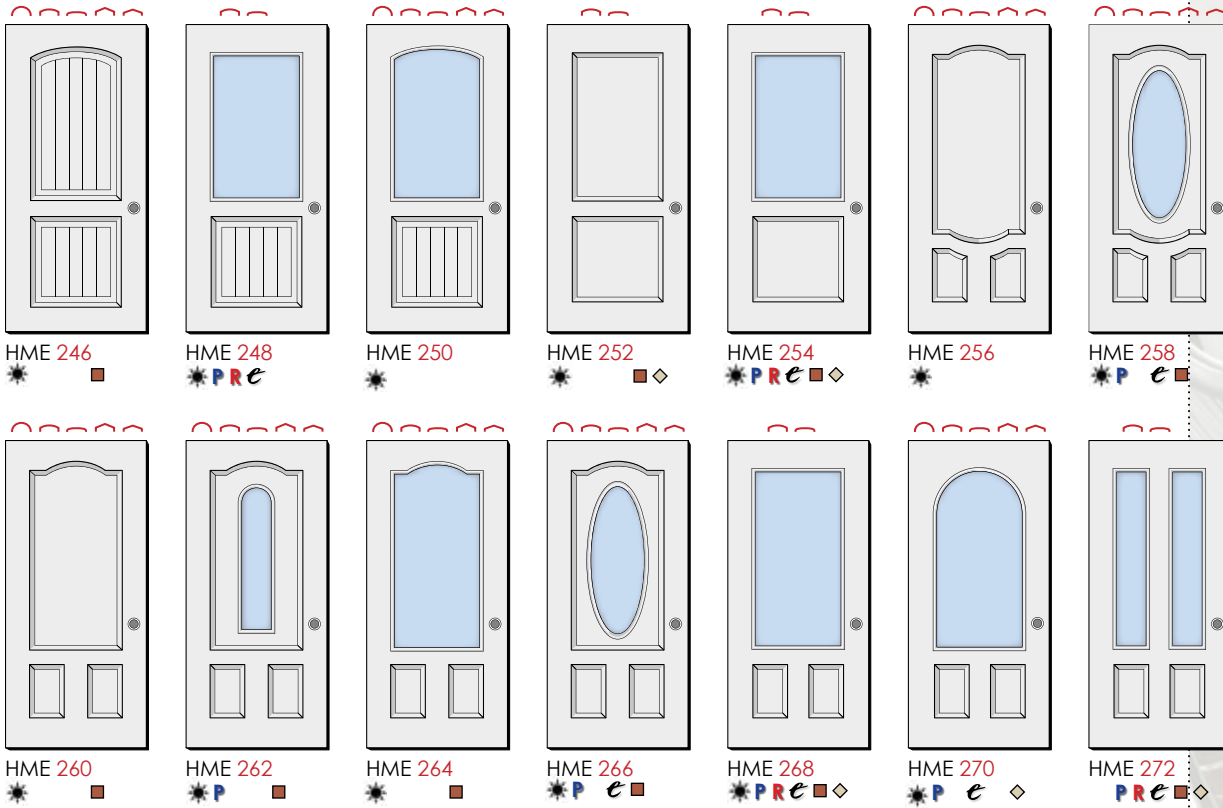

HS200 SERIES • ONE LITE SIDELITES

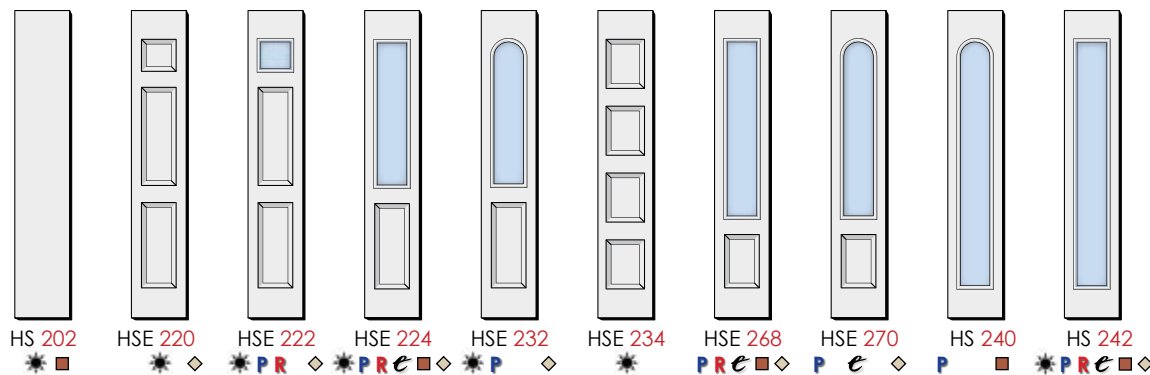

HT200 SERIES • ONE LITE TRANSOMS

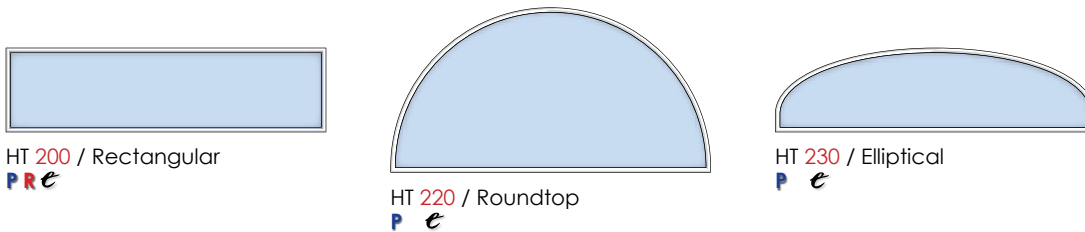

DOGGY DOOR

We have not forgotten your best friends. A pet door can be added to doors without bottom embossed panels.



CUSTOM DOOR OPTIONS:

- R Rain Glass P Pebbled Glass ■ Also Available in Textured Fiberglass
 - e Available in Low-E Glass ◇ Also Available with Raised Trim Panels
 - * 2009/2010 Stimulus Bill Tax Credit Qualified with Low-E, Low-E Plus and Decorative Glass with caming.
- Recommended Arch tops are Highlighted in Red

HM300 SERIES • EXTERNAL GRID STYLES

All HM300 Series Doors & Sidelites are available in Textured or Smooth Steel

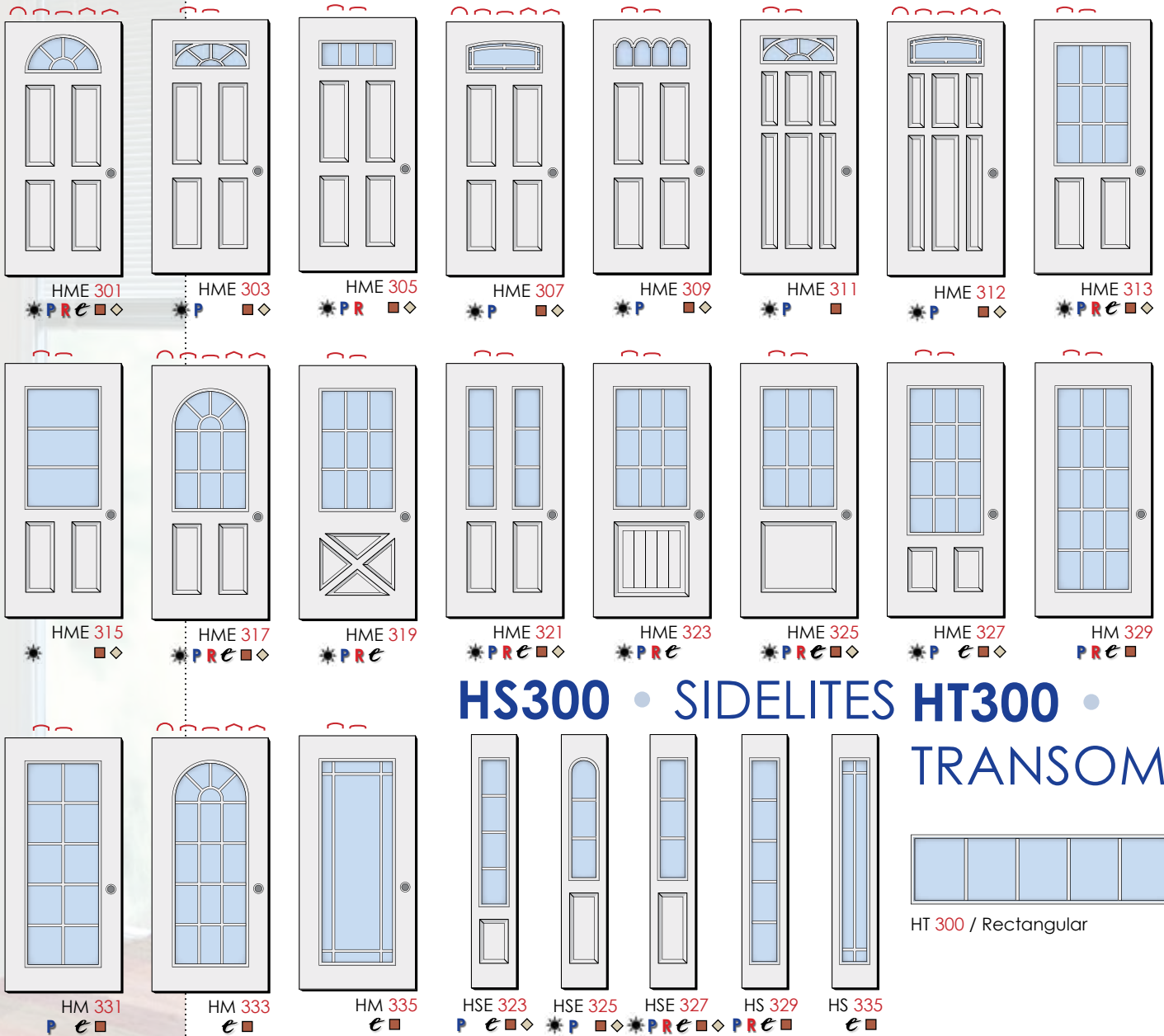

SIMULATED DIVIDED LIGHT



CUSTOM DOOR OPTIONS:

R Rain Glass P Pebbled Glass

■ Also Available in Textured Fiberglass

e Available in Low-E Glass

◇ Also Available with Raised Trim Panels

* 2009/2010 Stimulus Bill Tax Credit Qualified with Low-E, Low-E Plus and Decorative Glass with caming.

Recommended Arch tops are Highlighted in Red

HM400 SERIES • INTERNAL GRID STYLES

All HM400 Series Doors & Sidelites are available in Textured or Smooth Steel



HS400 • SIDELITES

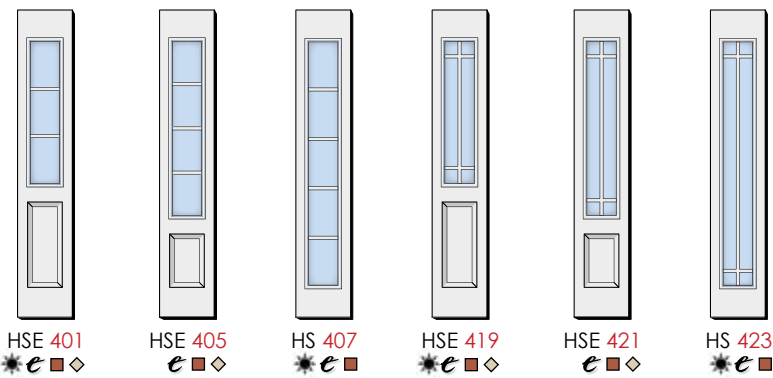

INTERNAL GRIDS

Thermally sealed between two pieces of tempered glass, Internal Grids provide the same classic beauty as external grids, but with the added advantage of an easy-to-clean design. The internal grids are available in two different colors: White and Champagne.



White

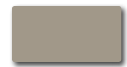

Champagne

HT400 • TRANSOMS

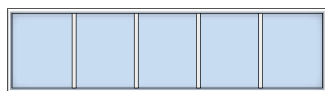

HT 400 / Rectangular

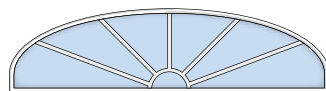

HT 430 / Elliptical



MINI BLIND ENTRY DOORS

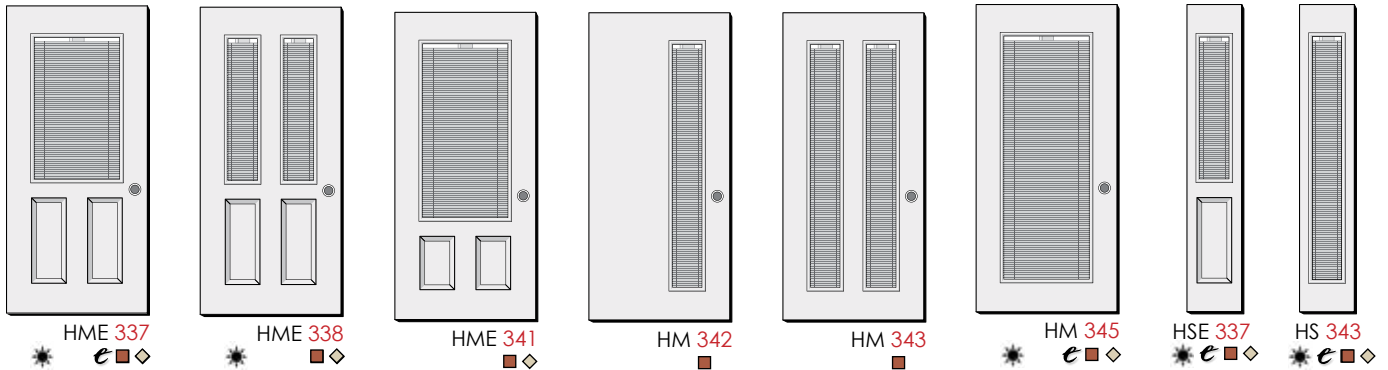

Thermally sealed between two pieces of tempered glass, Internal Blinds combine the privacy and light control of conventional blinds, with a hassle-free internal design requiring no dusting at all. Simply use the top control to tilt through a full 180° rotation or use the side control to raise or lower the blinds.

MINI BLINDS WITH INTERNAL GRIDS

HM 447 Door in a Patio Configuration ▼

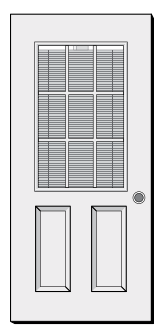

HME 439
* e ■ ◇

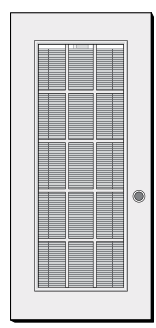

HM 447
* e ■



CUSTOM DOOR OPTIONS:

- Rain Glass ■ Pebbled Glass ■ Also Available in Textured Fiberglass
- e Available in Low-E Glass ◇ Also Available with Raised Trim Panels
- * 2009/2010 Stimulus Bill Tax Credit Qualified with Low-E, Low-E Plus and Decorative Glass with caming.

Available in all HMI door styles.

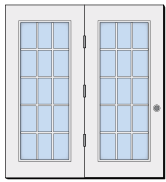

Patio Door Configuration

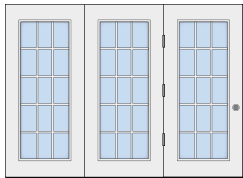
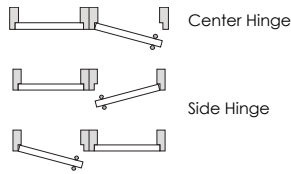

Triple Patio Door Configuration

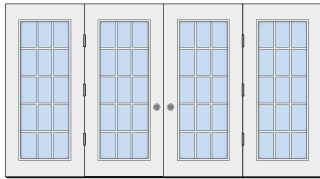
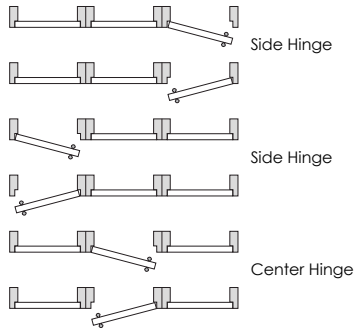

Double Door French Configuration



HM 423 Doors in a French Door Configuration ▲

SLIDING SCREEN

One of HMI's newest additions is the innovative Sliding Screen Door. Exclusively manufactured by HMI, the Sliding Screen Door features a unique aluminum extruded design ensuring highest quality construction and durability. Unlike other sliding screens where all the weight is placed upon a floor mounted track, HMI's design uses a dual-wheel hung design allowing for a smooth and stress-free operation.

Customers can choose from either a Single Sliding Screen configuration (*Illustrated to the right*) or a Dual Sliding Screen configuration.

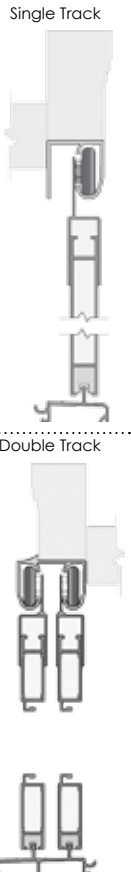

▼ HM 345 Doors in a Patio Configuration ▼



FIBERGLASS ENTRY DOORS



HME 286

HME 288

HME 290

● HME 292HN

● HSE 292HN

HME 280

HS 242

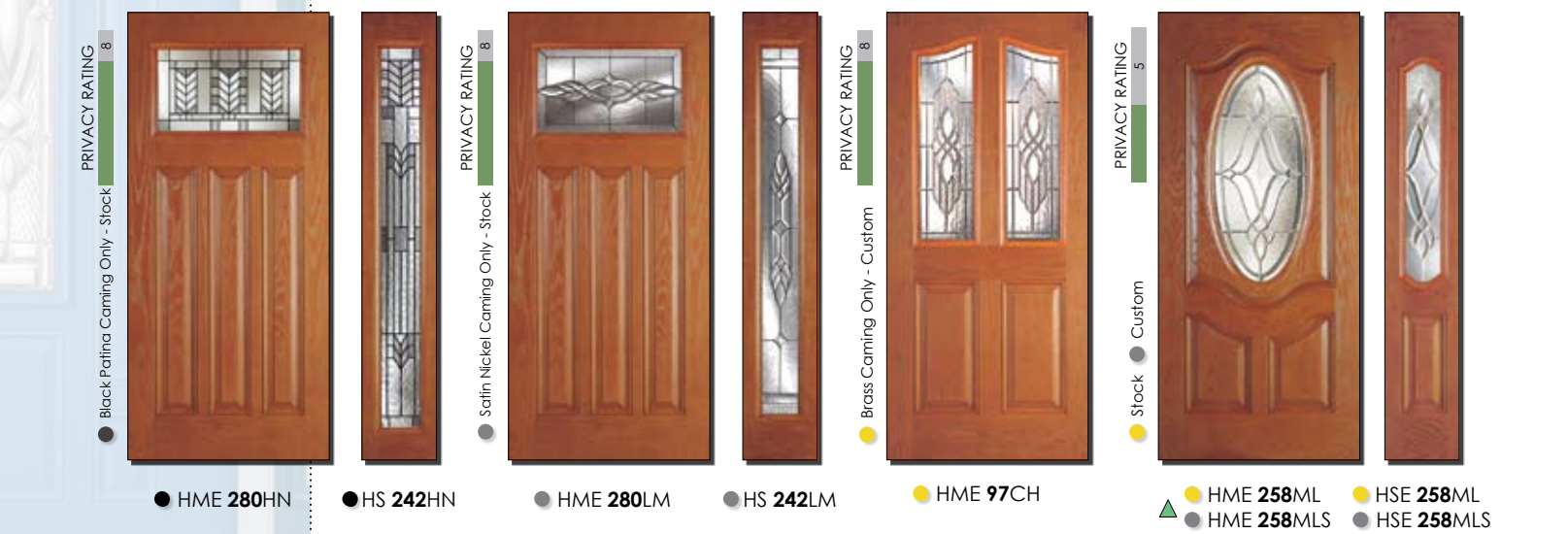

● HME 280HN

● HS 242HN

● HME 280LM

● HS 242LM

● HME 97CH

● HME 258ML

● HSE 258ML

▲ HME 258MLS

● HSE 258MLS



● HME 294PR

● HS 242PR

● HME 274W

● HSE 274W

● HME 274WS

● HSE 274WS

● HME 274WP

● HSE 274WP

THE FIBERGLASS ADVANTAGE



In addition to Steel Entry Doors, HMI also offers a wide range of Fiberglass Entry Doors. Available in textured surface, Fiberglass doors feature the beauty and detail of conventional wood doors but with added insulation value provided by the solid foam core and composite stiles and rails. All Fiberglass Doors are available in any HMI paint or stain finish.

Refer to pages 26-29 for more styles to choose from.

ENTRY DOOR



* ▲ HME 246



* ▲ HME 252

NEW!



* ▲ HME 256



* ▲ HME 260



* HME 274

NEW!

HME 290 Door ▼



* HME 276

NEW!



* HME 278



* HME 282

PRIVACY RATING
0



HME 284

- ▲ Available in Steel
- * 2009/2010 Stimulus Bill Tax Credit Qualified with Low-E, Low-E Plus and Decorative Glass with casing.

THE SAFEGUARD™ ADVANTAGE

▼ HME 246 Door

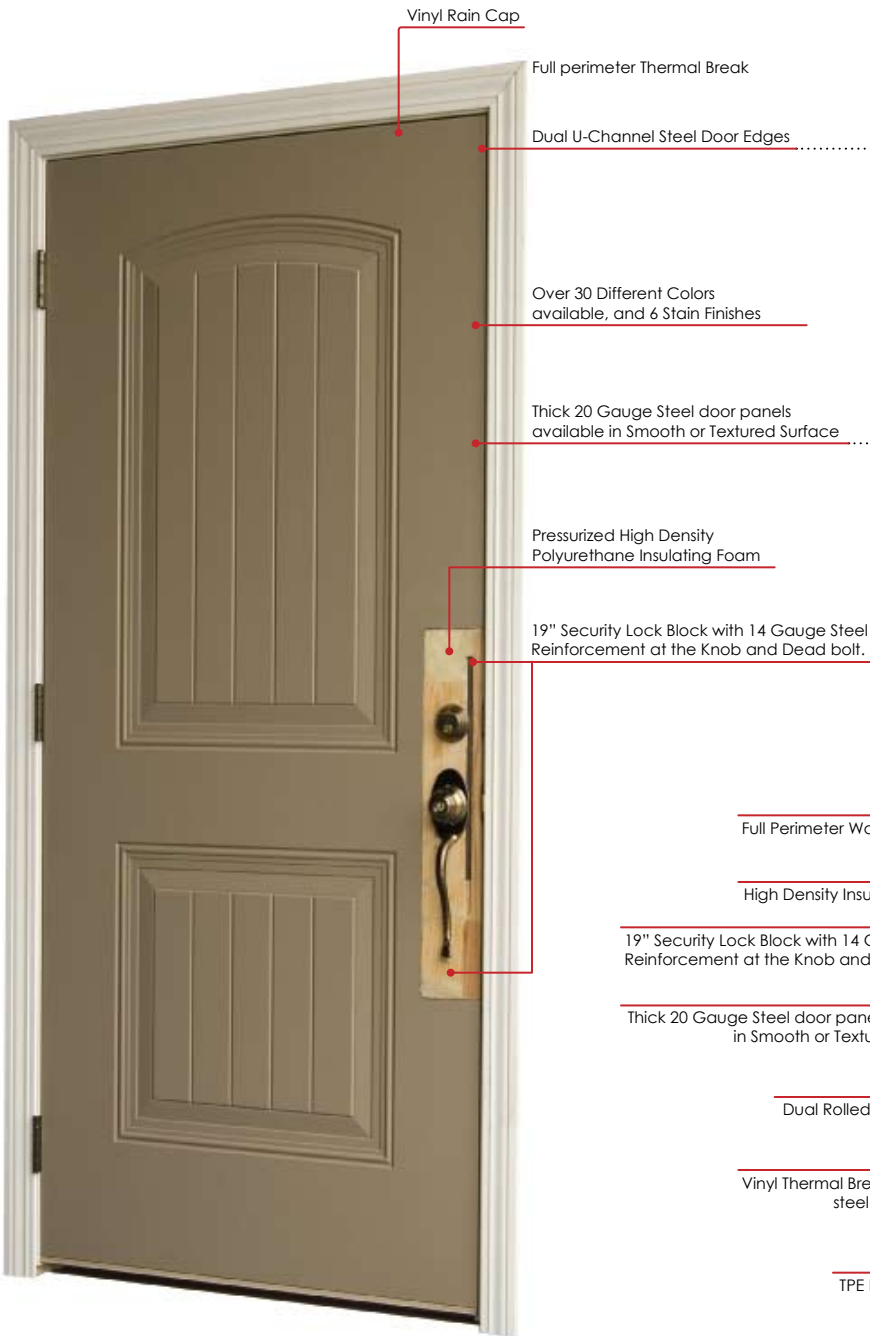

Vinyl Rain Cap

Full perimeter Thermal Break

Dual U-Channel Steel Door Edges

Over 30 Different Colors available, and 6 Stain Finishes

Thick 20 Gauge Steel door panels available in Smooth or Textured Surface

Pressurized High Density Polyurethane Insulating Foam

19" Security Lock Block with 14 Gauge Steel Reinforcement at the Knob and Dead bolt.

SafeGuard™ steel doors are warranted not to warp, split, shrink, or delaminate for as long as you own your home. *See warranty for additional details.*

The Dual U-Channel Steel Door Edges are custom made to the customer's specific door width instead of the conventional width-cut-down door slab. The 3-Dimensional design provides structural strength against warping and resistance against splitting from break-in attempts. In addition, the full perimeter of the door is sealed with a polymer thermal break providing greater insulation value and preventing any exposed steel edges.

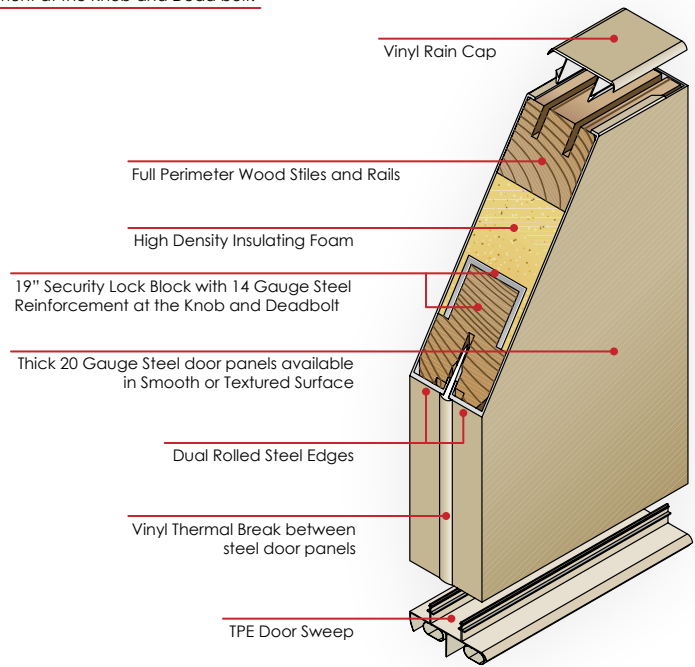

Vinyl Rain Cap

Full Perimeter Wood Stiles and Rails

High Density Insulating Foam

19" Security Lock Block with 14 Gauge Steel Reinforcement at the Knob and Deadbolt

Thick 20 Gauge Steel door panels available in Smooth or Textured Surface

Dual Rolled Steel Edges

Vinyl Thermal Break between steel door panels

TPE Door Sweep



Magnetic Weather-strip for positive air seal along the header and lock side



Q-Lon Weather-strip for compression weather seal along hinge side



Anti-Pry Ball Bearing Hinges
Available in Aged Bronze, Satin Nickel, Polished and Antique Brass

Bronze

Satin Nickel

Brass



Adjust & Lock Threshold with Thermal Break

NEW CONSTRUCTION JAMBS

Primed Wood Jamb - Standard

These jambs are vinyl wrapped treated wood for standard sizes: 4 9/16"; 5 1/4"; 6 9/16"; and all other sizes are made of treated wood with aluminum capping. Both vinyl wrapped and aluminum capped jambs are available in smooth and textured surfaces, which can be finished to match the door color. The treated wood underlay is damage resistant to the elements. Whether you have the vinyl wrapped or aluminum capping they are the finishing touch to a sophisticated entrance.

Ultraframe™ Reinforcement - Optional

Exclusively by HMI our Patented Ultraframe™ allows you to have an elegant entryway with extra security. Each Ultraframe™ has 18 gauge reinforcement steel plates placed behind the deadbolt, knob, and hinges. The steel reinforcement plates are constructed in an "L" shape, which provides strength for a stronger mounting point and resistance against break-ins.

18 Gauge Steel Reinforcement
ULTRAFRAME™
Lock Side

Exclusive HMI Security Tab at Knob Location

18 Gauge Steel Reinforcement

Hinge Side

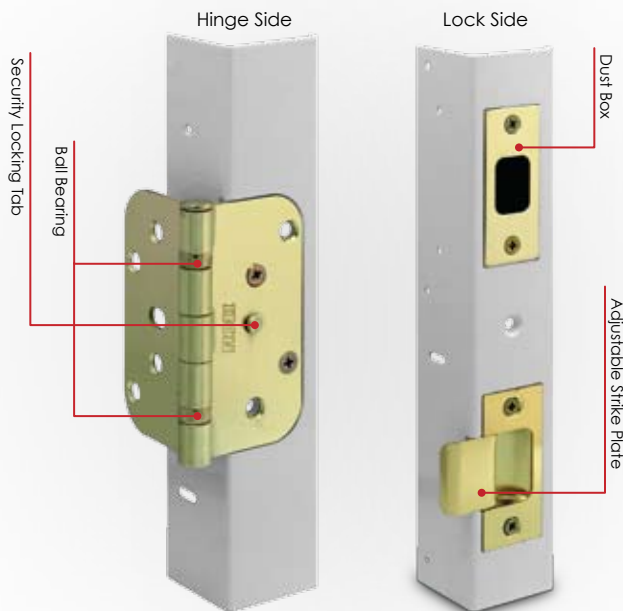

STEEL REPLACEMENT FRAME

Steel Replacement Frames are also available if preferred over a new construction jamb. The frame is constructed of heavy gauge galvanized steel with 10 gauge plates located on the lock and hinge sides for extra reinforcement to help keep intruders out. All replacement frames are finished with a powder coating.

Stained Painted Unfinished Primed



3 1/4 Colonial

2 3/4 Colonial

2 3/4 Clamshell

INTERIOR CASING

Interior casing can be painted or stained to match interior decor, supplied primed or unfinished for customer to finish.

JAMB & FRAME UNIT OPTIONS

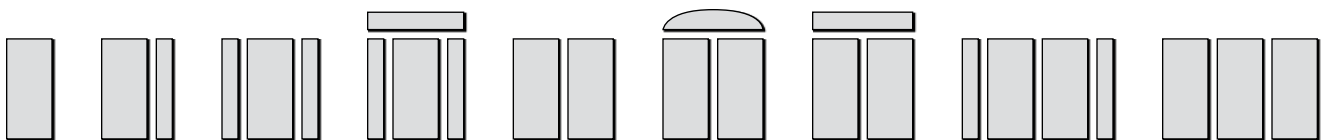

HMI offers an almost endless amount of Jamb & Frame Configurations. Illustrated here are the most common configurations, but customers may order any configuration they choose.

12 POINT LOCKING SYSTEM

Home is our safe shelter

It is a place where we find comfort. It protects our possessions, but more importantly it protects you and your family members. Unfortunately, many homes are not as safe as the owner's think:

- Every 14 seconds a home is burglarized.
- More than 50 percent of all residential burglaries, entry is gained through a door.
- High quality 20 gauge steel doors, locks and key control are your first line of defense against a break-in.
- If you have a standard key, it can be copied at any hardware store. Ezcurra security keys can only be duplicated through SafeGuard™ Doors by using a supplied security key card.
- With Ezcurra you don't have to worry that someone has a key that you don't know about, and who might use it to unlock your door.

- Burglary Resistant - High quality locks protect you, your loved ones, and your possessions
- Twelve points of contact, ten horizontal backsets, two vertical backsets
- * • Six of the deadbolts are inserted with tempered steel pins to prevent sawing
- Cylinders are drill proof by tempered steel pins
- Anti - picklock profile
- Cylinders have double pin rows on both sides, this coupled with an extra locking device on the side, makes these cylinders highly sophisticated
- Optional anti-panic hardware available
- Concealed, tamper-proof deadbolts leaving a flush door surface
- Locks are fire rated
- Lifetime mechanical warranty
- Beautifully designed handlesets to compliment any style entrance
- Single or double cylinder located at the handle for easy access and fast exit
- If keys are lost, only the cylinder would need to be changed
- Available for doors from 74" to 96"
- Available in replacement and new construction steel doors
- Factory installed (only handles installed on-site)

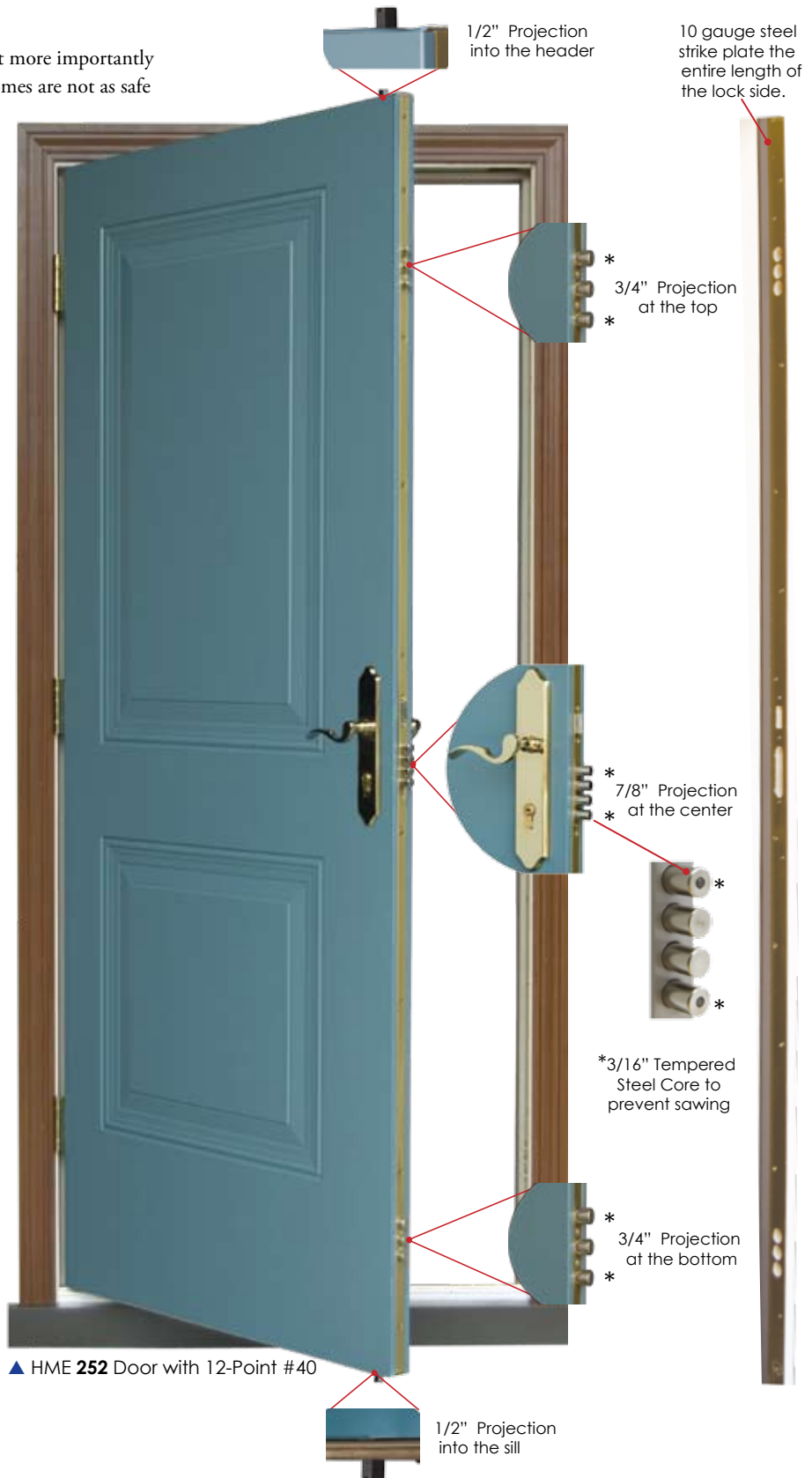

▲ HME 252 Door with 12-Point #40

4 POINT

4 POINT MORTISE LOCK



▲ HME 246 Door with 4-Point #42

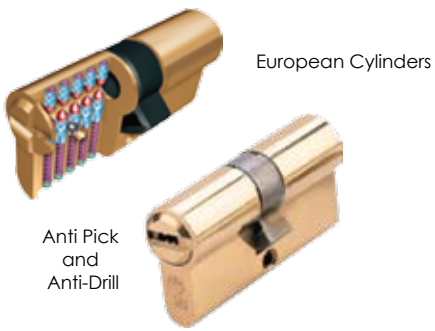

European Cylinders

Anti Pick and Anti-Drill



Four nickel keys

4 1/4" Finger joint lock block the entire length of the lock side



14 gauge reinforcement U-channel the entire length of the lock side

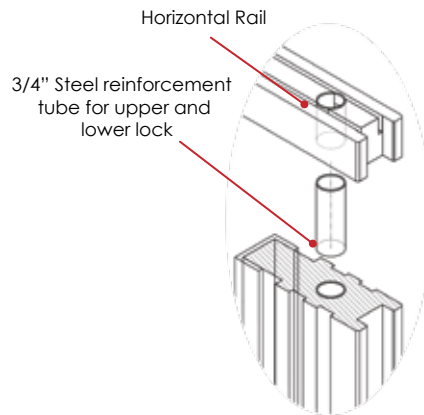

Horizontal Rail

3/4" Steel reinforcement tube for upper and lower lock

Patent Pending

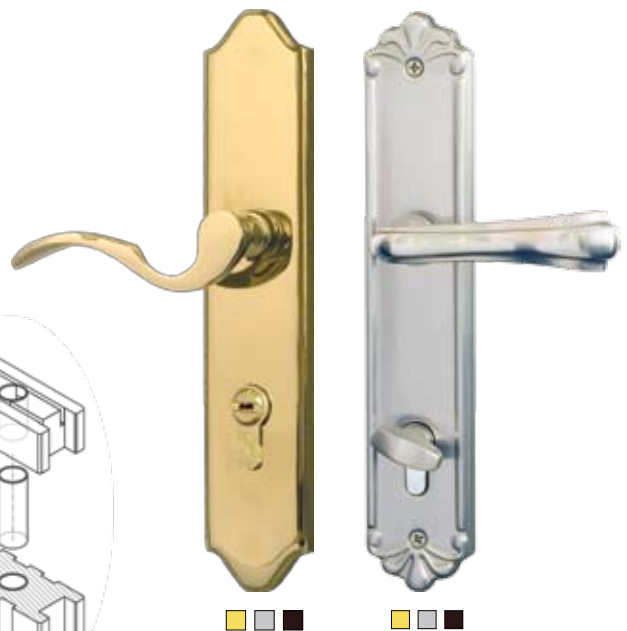

Oil Rubbed handle set available only in polish brass or satin nickel backset plate

HARDWARE

HARDWARE FINISHES



Polished Brass - Lifetime Finish



Antique Brass - 10 Year Finish



Satin Nickel - Lifetime Finish



Aged Bronze - Lifetime Finish

PREMIUM HANDLE SETS Lifetime Finish



Addison #24



Plymouth #25



Interior Georgian Knob



Interior Accent Lever

Interior options for handle sets are the Georgian Knob or the Accent Lever. A B360 Single Cylinder Deadbolt is standard with handle sets.

HMI offers four different hardware finish options:

- Polished Brass
- Satin Nickel
- Antique Brass
- Aged Bronze



Camelot #26



Bowman #27

Standard Handle Sets

Deadbolt Options



Exterior



Interior

Georgian Keyed Knob #19



Exterior



Interior

Accent Keyed Lever #21



B360 Double Cylinder



B362 Single Cylinder

Accessories



Std Mail Slot - (3 x 10)
Magazine Mail Slot - (3 x 13)

L

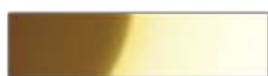

Magnetic Kick Plate



Peepsite



Peek-O Viewer



Knocker



Lifetime Knocker

L



Peep Knocker



Lifetime Peep Knocker

L



S Style Knocker

L



Decor Pitcher Handle

L

L Available in Lifetime Polish

HARDWARE

Mortise Lock: The ideal solution for narrow doors with larger glass.

DISTINCTIVE HANDLE SETS WITH TUBULAR BACKSETS



Ribbon & Reed #30



Wilshire #34



Marietta #32



Mortise Lock #36

MORTISE LOCKS WITH SECURITY FEATURES



Regency #54



Manhattan #58



Memphis #56



Salem #52



Jackson #50

KEYLESS ENTRY



Digital Single Cylinder Deadbolt #28



Digital Accent #29

EZ SET



Exterior



EZ Set Single Cylinder #5



Exterior



EZ Set Double Cylinder #5

FRENCH SIDELITES



French Sidelites work just like our Double Doors to provide you with another innovative option.

Hinged on opposite sides of the jamb, French Sidelites allow for the sidelite and door to be opened simultaneously, providing a larger entryway opening.

Enjoy the beauty of a classic door and sidelite with the practical space to move household appliances and furniture through.

◀ HME 258N Door and HS 242N Sidelite ▶



SAFEGUARD™ QUICK SHIP DOORS

Available in 5 business days or less – Guaranteed! Quick ship doors are painted white, are inswing and have a steel replacement frame. They are constructed of smooth 20 gauge steel with clear glass, and polished hinges. Available sizes are listed below each style Quick Ship door.

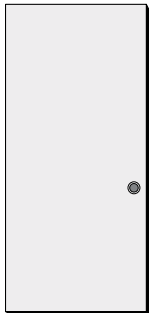

★ HM 202Q

28 x 80"
30 x 80"
32 x 80"
36 x 80"

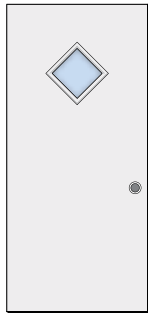

★ HM 206Q

28 x 80"
30 x 80"
32 x 80"
36 x 80"

Embossed Panels

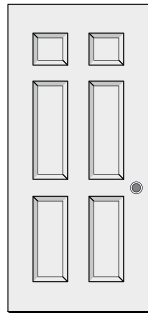

★ HME 220Q

30 x 80"
32 x 80"
36 x 80"

Embossed Panels

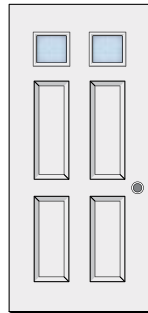

★ HME 222Q

30 x 80"
32 x 80"
36 x 80"

Embossed Panels and External Grid

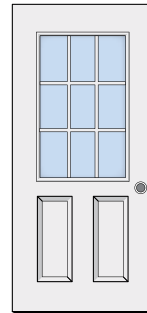

HME 313Q

30 x 80"
32 x 80"
36 x 80"

Embossed Panels and External Grid

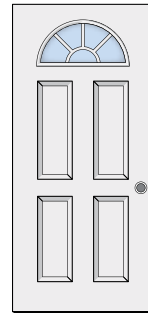

★ HME 301Q

30 x 80"
32 x 80"
36 x 80"

PAINT, POWDERCOAT AND STAINS

Paint (P - Matching Powder Coat finish for Aluminum and Security Storm doors)



Stain Finishes (For Entry Doors Only)



Note: These sample colors do not accurately reflect actual painted/stained or powdercoated surface colors due to limitations in the printing process. Please see your sales representative for SafeGuard™ color chips.

All 20 gauge **SafeGuard™** steel entry doors are galvanized to A40 and chem treated to prevent rusting. **SafeGuard™** steel and fiberglass doors are first primed with a durable undercoat that is oven-cured for lasting resiliency.

Paint - A final paint finish is applied to the doors and oven-cured a second time forming an enduring lustrous look.

Stain - Hand applied to give a wood grain appearance, it is then top coated with a 2-part clear urethane protective coat with a UV inhibitor. It is then oven-cured a second time forming an enduring lustrous look.

Powdercoat - Aluminum and security storm doors are chem washed then oven dried. The powdercoating is electrostatically applied and double baked to create a durable resilient finish.

* Due to possible heat buildup, the warranty for entry doors does not apply to the door or glass trim painted in these colors when installed behind storm doors.

** Trim color only



BE SURE TO ALSO LOOK AT OUR
SECURITY DOOR CATALOG

Distributed by:



www.hmidoors.com
Copyright © 2010 Household Metals, Inc.
SafeGuard™ is a trademark of Household Metals, Inc.